

Wireless Microphone Basics



Table of Contents

Introduction	3
Components of a Wireless System	4
The Carrier Signal	7
Terms to Know	9
Wireless Microphone Options	14
Antenna Choice and Distribution	15
Quick Review	16
Words of Wisdom	17
Wrap-up	18

Introduction

Tell Me About Wireless Microphones

If you need to know how wireless microphones work, what's available, and which is best for your needs, you've come to the right place.

Wireless Microphone Basics gives you just enough information to help you make a smart decision... but not enough of the technical stuff to bore you. You'll learn about the components of a wireless system, how a wireless signal travels, and some differences between wireless microphone types. This overview will leave you confident that you can choose the best wireless system for your needs and get the best possible results from the equipment you choose.

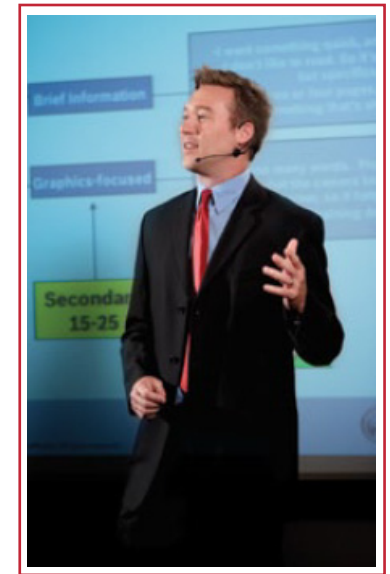

What makes EV the expert?

Experience. Dedication. Passion.

Electro-Voice has been in the audio equipment business since 1930. Recognized the world over as a leader in audio technology, EV is ubiquitous in performing arts centers, sports facilities, houses of worship, cinemas, dance clubs, transportation centers, theaters, and, of course, live music. EV's reputation for providing superior audio products and dedication to innovation continues today. Whether EV microphones, loudspeaker systems, amplifiers, or signal processors, the EV solution is always a step up in performance and reliability.

Components of a Wireless System

What makes wireless work?

A wireless microphone is pretty slick: no wires to trip on, no cords to untangle. It's just you and your mic out there, taking on the world. But that handy little mic wouldn't do a thing for you without the other components of a wireless system. Let's take a peek behind the scenes to see what really makes a wireless mic work.

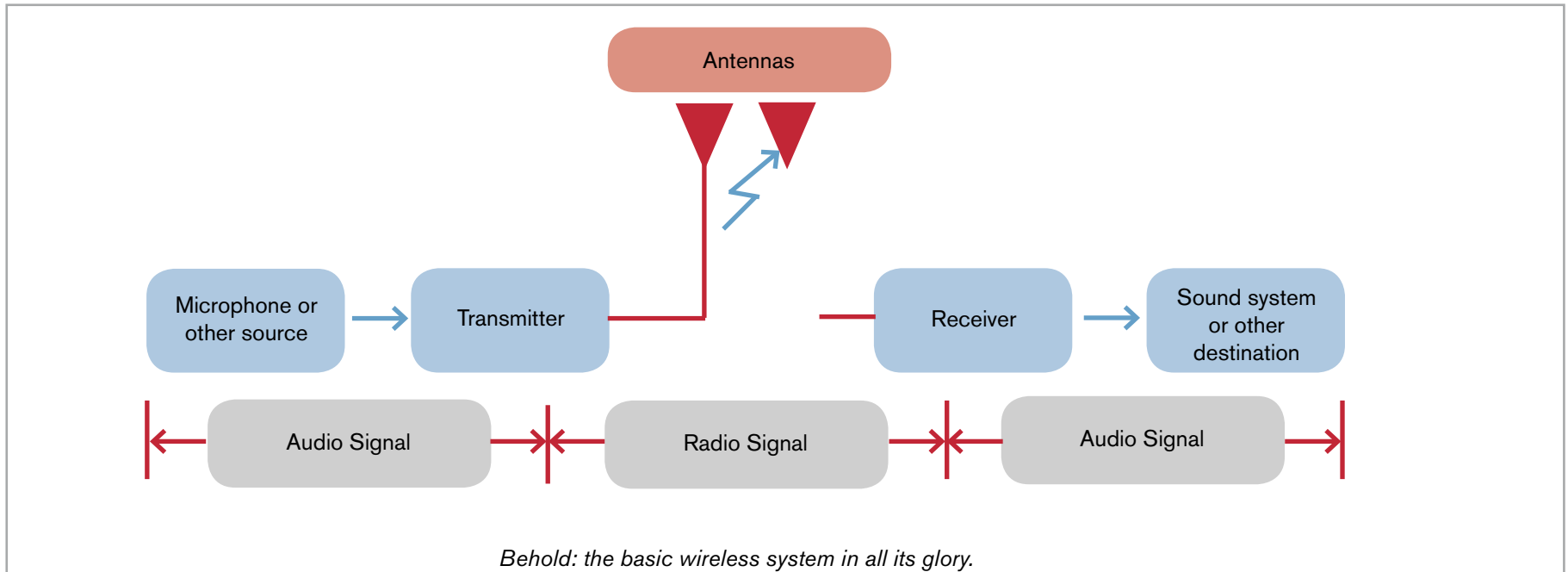

The basic principle behind a wireless system is converting the audio signal being input at the microphone into a radio signal that can be transmitted over the air to the receiver, and then turning it back into an audio signal that can be output to the rest of the sound system. This is all accomplished by fancy electronic circuits with long and complex names like “programmable frequency divider and PLL controller” and “intermediate frequency filter.”

The big takeaway here is that you need two things to make your wireless mic work: a **transmitter** and a **receiver**.

Transmitters

To get a signal from one place to another, you need a way to send it. Corded mics send electrical impulses along a cord, but wireless mics, which are commonly referred to as “cordless”, use a transmitter. Transmitters and antennas are built into wireless microphones, either within the handheld unit or within the bodypack.

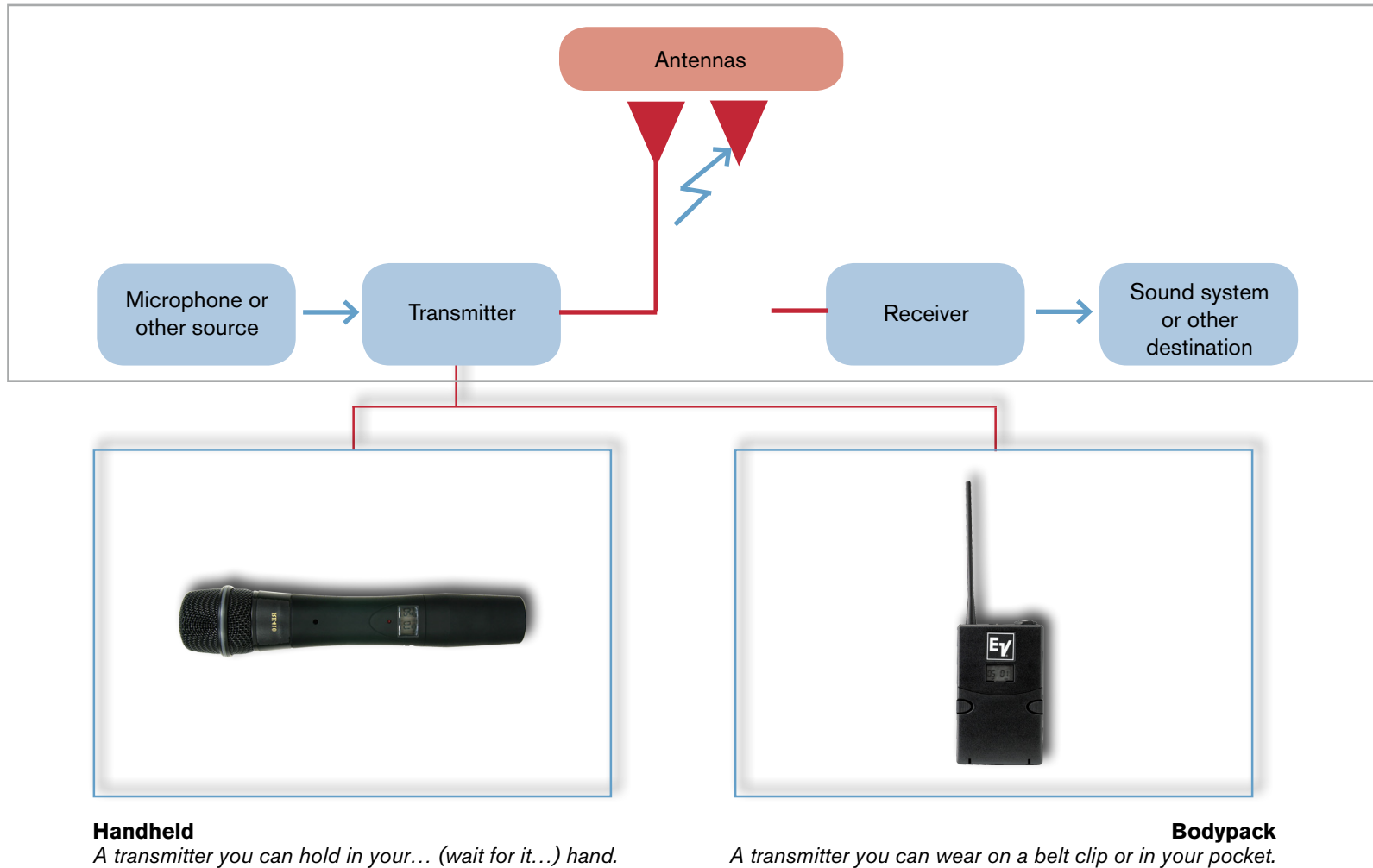

Receivers

Once the transmitter sends the signal through the air, the receiver picks it up and sends it on to the rest of the sound system.

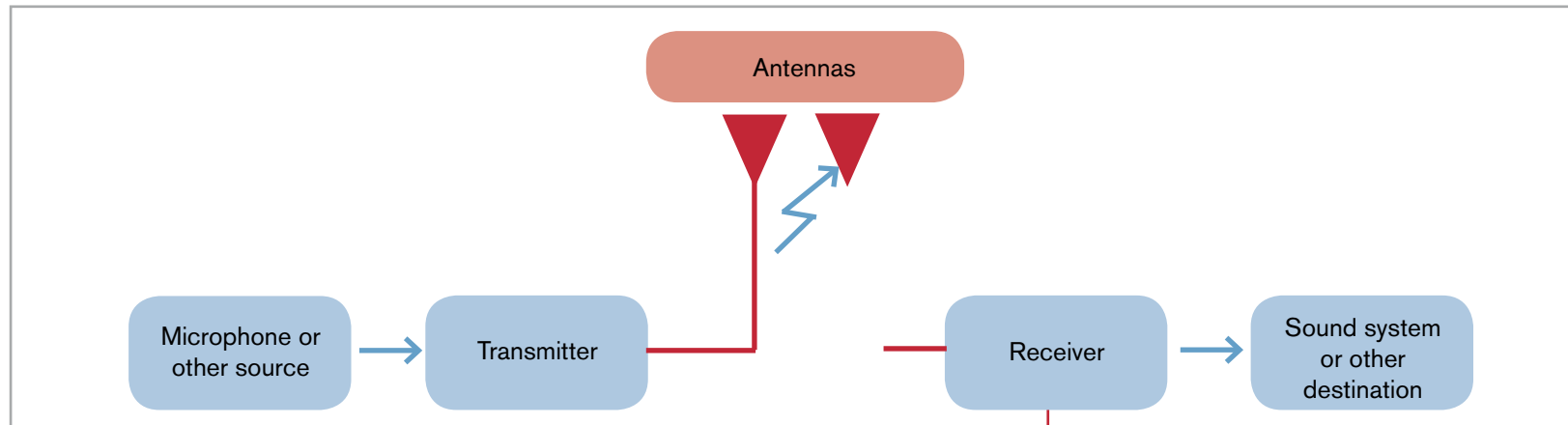

A basic dual-antenna receiver.

A receiver generally has two antennas (OK, you language purists out there—*antennae*). They work together to ensure the receiver is picking up the strongest signal possible from the transmitter. The antennas can either be mounted directly on the receiver or they can be mounted remotely. (More on that later.)

The Carrier Signal

What is a carrier signal?

In a wireless system, the carrier signal is the radio frequency at which you transmit your information (in this case, the audio that goes into your wireless microphone). The audio signal modulates, or alters, the carrier frequency in a way that can be decoded in the receiver to recover the audio.

There are many types of RF modulation, but two of the most common are amplitude modulation (AM) and frequency modulation (FM). Those initials should look familiar if you ever listened to the radio before XM, satellite radio, Pandora, Spotify, and podcasts took over the world.

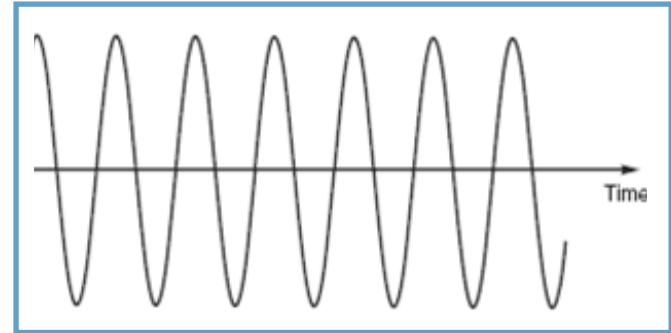

A carrier signal is a sinusoidal wave that maintains the same amplitude (height) and frequency (spacing) over time. One of these characteristics is varied when the carrier is modulated by an audio signal, depending on the type of modulation.

Fun Fact:

AM radio stations can only transmit on the frequency bands between 535 kHz and 1.7 MHz. FM radio stations can only transmit on the frequency bands between 88 MHz and 108 MHz. Wireless microphone systems are only allowed to transmit in specific frequency bands. In the United States, most wireless mics operate between 470 and 698 MHz. Why? Only the FCC knows.

Other countries may have different frequency ranges reserved for wireless microphones. If you're travelling to another country, don't assume that you will be able to (legally) operate your mics there!

How does wave modulation work?

In carrier signal modulation, the audio signal (for example, your voice) that's translated to a radio signal hitches a ride on the carrier signal, which actually results in the creation of a new frequency.

In amplitude modulation, the audio signal determines the amplitude of the radio signal, which looks something like this:

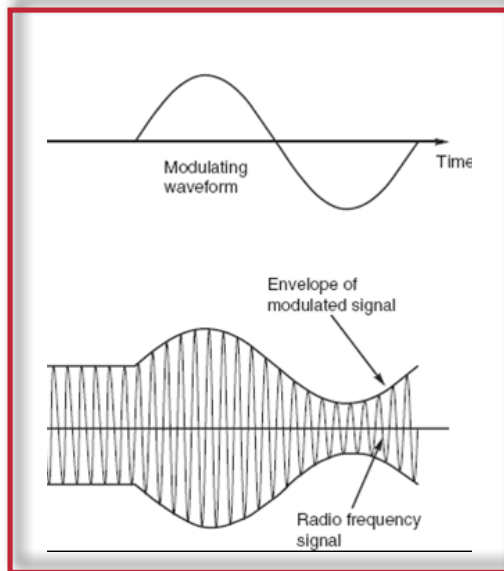

This method of modulation is good for transmitting signals over large distances, but it is more susceptible to noise. That's not what you want in a microphone system.

Pro Tip:

When you transmit at a given frequency, your signal actually takes up bandwidth that's about 200 kHz wide. So if you transmit at 650.000 MHz, your actual transmission bandwidth is about 649.900 to 650.100 MHz.

In frequency modulation, the carrier signal is modulated by slightly changing the carrier frequency based on the audio signal, which looks something like this:

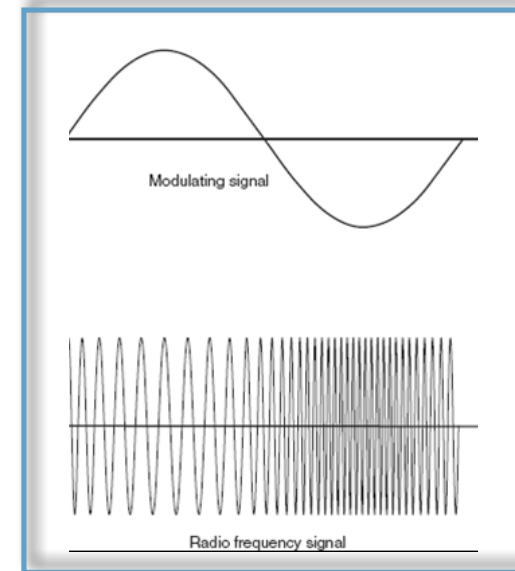

This is the method of modulation that most wireless microphones use. It allows for higher fidelity and less noise in the signal.

Wireless Terminology

Multipath Interference

When a transmitter sends out a signal, the signal can travel by two or more paths (for example, if it bounces off a nearby object) and reach the receiver at different times.

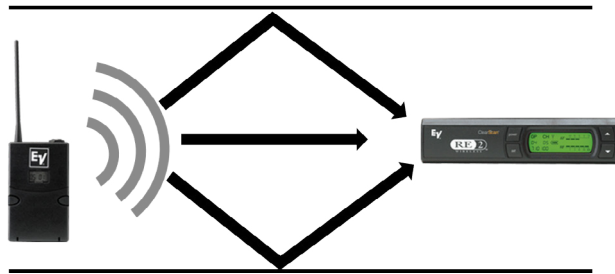

If the time difference is just right, the signals cancel each other out, causing the radio frequency (RF) to drop out. That's called multipath interference. It's not good.

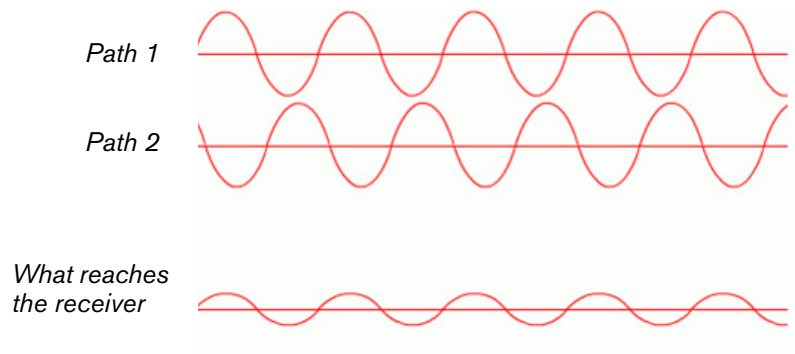

Diversity

Diversity is the ability of the receiver to manage a transmitted signal that arrives at different times, i.e., multipath interference. Manufacturers approach diversity in different ways: through antenna design and placement, through the circuitry within receivers, and with magic spells and incantations. (OK, not that last one.)

Some receivers, like the EV R300 series, have two antennas *and* a circuit that enables only the antenna receiving the strongest signal to pass it through to the receiver. The other antenna just sits there looking busy.

The reason to have two antennas is driven by the idea that two antennas will probably not experience multi-path dropout at the same time. It's okay for one to have it as long as the other still has a strong enough signal. That's why it's a good idea to remote mount your antennas if possible, and to space them out by at least six feet.



Squelch

Squelch is a function within the receiver that helps it filter out extra signals. It's particularly helpful when you're trying to use a wireless system in an RF-heavy environment (e.g., near an airport or in a building with a wireless PA system). Squelch mutes the output of the receiver if the strength of the signal you're trying to receive is too low at the antenna, or if there is too much interference from stronger signals. This protects you from bursts of static and noise instead of the sounds you're expecting to hear from your microphone. One way to improve squelch operation is by adding an inaudible tone key or tone code signal to the radio signal. As long as the tone code is strong enough, the receiver can lock on to the desired signal.

As with diversity, different manufacturers provide the squelch function in different ways. In EV receivers, the squelch circuitry is built in. You can increase or decrease it as needed.



Pro Tip:

You can usually leave your squelch alone. If you turn it up too much, you can block the signal from the transmitter unless you are really close to the antennas. If you turn it too far down, you'll be more susceptible to interference.

Comping

Comping is the process of compressing a signal in the transmitter before it's transmitted, and then expanding it again in the receiver before it gets to the rest of the audio system.

The net effect of comping is to reduce the amount of background noise, while providing a natural-sounding audio signal. It also allows a much smaller signal to be transmitted, thereby reducing the bandwidth the transmission uses.

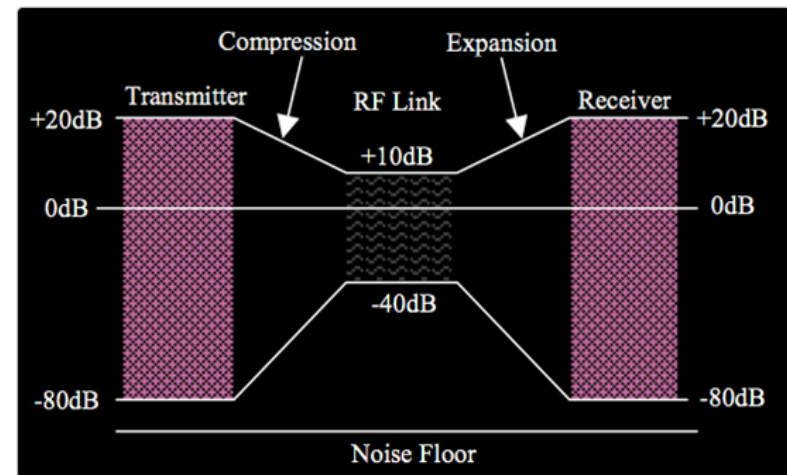

Frequency Coordination

Frequency coordination is the selection of multiple frequencies that will work together in one area without interference problems. You might be thinking: “Wait, as long as my systems are all on different frequencies, shouldn’t everything work great?” Well, it’s not that simple. A couple of things can throw a monkey wrench into the signal selection process.

- 1 First of all, wireless microphones produce signals in frequency ranges that compete against other unlicensed wireless devices and TV channels. With all this competition, it can be tough to find a clear frequency for a single wireless mic system, let alone multiple signals when you’re using multiple wireless systems. Digital TV channels only make it harder to find open frequencies because they take up so much more of the spectrum than analog TV channels.

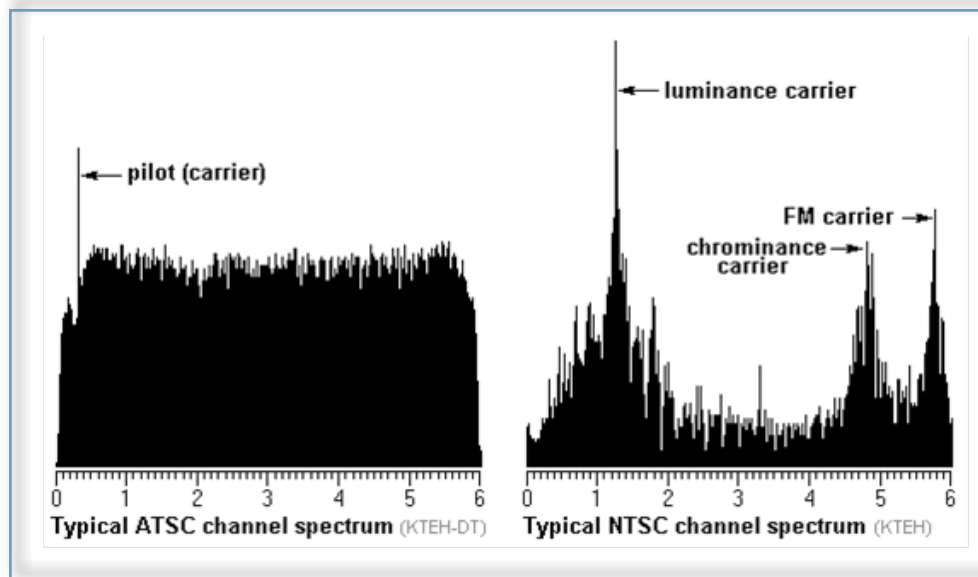

Digital TV channel, hogging up all the frequencies like a big jerk.

Analog TV channel, kindly leaving lots of room for other signals.

Frequency Coordination, cont.

- 2** A second potential complication is intermodulation distortion. When multiple transmitters operate near each other, their RF signals can interfere with each other and generate additional RF signals at frequencies that have nothing to do with any or the original audio signals. In audio, when you get something at the output that wasn't part of the input, it's called "distortion". The way to minimize this type of distortion is to pick carrier frequencies carefully so that systems won't interfere with each other. EV's ClearScan technology does this for you.

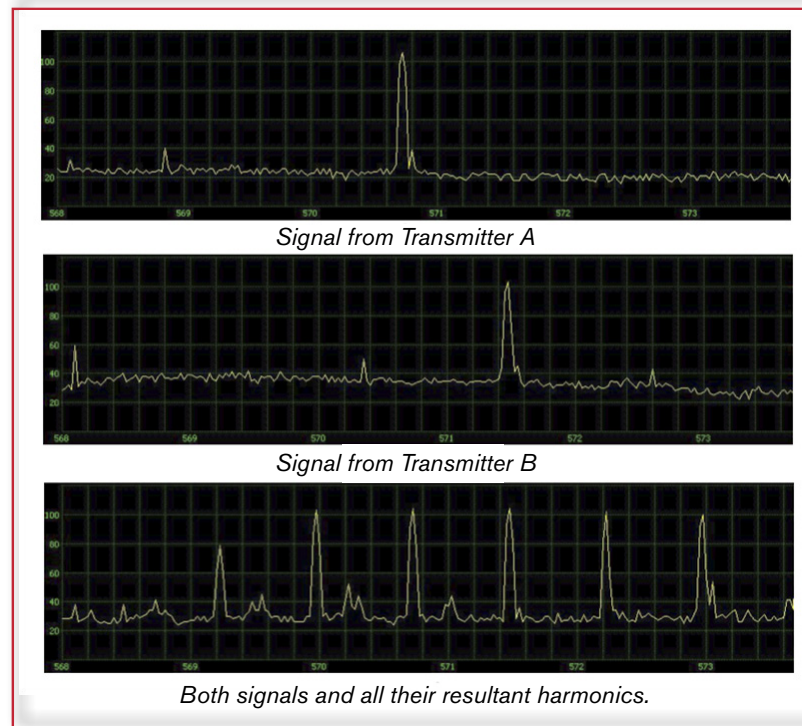

Pro Tip:

The FCC prohibits the operation of wireless microphones in the 700 MHz Band, i.e., the frequencies between 698 MHz and 806 MHz. These frequencies are reserved for emergency personnel and public-safety communications. Be sure any wireless system you use does not operate in the 700 MHz Band.

Frequency Coordination: Software Saves the Day!

ClearScan, which is built into every EV wireless system, will automatically scan all available groups/channels or frequencies, and find the group with the clearest channels. Even better, all channels within a specific group are pre-coordinated to play nicely together.



Pro Tips:

Before purchasing any of our wireless systems, you should check the EV Frequency Band Selector, a free, online software tool that recommends the systems with the most available frequencies in your local area. There's a link to the EV Frequency Band Selector on our home page at <http://www.electro-voice.com>.

Wireless Microphone Options

Types of Wireless Mics

These are the most common types of corded microphones you'll find:

Handheld



Headworn



Lapel



The transmitter is built directly into the handheld microphone; headworn and lapel mics connect to a bodypack transmitter.

For more information about types of microphones, see Electro-Voice Audio 101: Microphone Basics.

Wireless Mic Systems

Wireless microphone systems range from basic to complex, sturdy enough to indestructible, inexpensive to... well, really expensive. Your needs and expectations will help you determine which level of wireless mic system will be best for you.

Entry Level	Mid Level	High Performance
Least expensive	Moderately expensive	Most expensive
Good, basic construction	Durable plastic or light-weight metal construction, good for regular use	Good for heavy-duty use (and people with butterfingers); most durable systems for high-profile or touring applications
Lowest output power; smallest number of compatible systems (i.e., wireless systems that can operate in the same location)	Moderate output power; better auto-scan features, supports more compatible channels	Highest output power, possible variable output power; typically offers highest number of compatible systems
Comes with basic or limited functions for reducing interference	Comes with several functions for reducing interference and improving performance	Comes with many upgraded functions for reducing interference; best wireless performance
Example: <ul style="list-style-type: none"> EV R300 Series 	Example: <ul style="list-style-type: none"> EV RE-2 Series 	Example: <ul style="list-style-type: none"> EV RE-2 Pro Series

The EV R300 system provides exceptional value by offering metal housings, ClearScan, and the capability of operating up to 8 compatible systems—all at an entry-level price.

Antenna Choice and Distribution

Which antennas do I need?

Most receivers come with antennas, and that will usually be all you need. But sometimes—if you're working outdoors or you're in a location with a lot of interference—you'll find yourself needing a little more flexibility or power than you can get out of the box.

Some antennas are remote-mountable, which means they're not mounted to the receiver, so you can place them wherever they need to go. A good example is the FA-GW ½ wave plastic standard whip. The CLA series antennas are also remote-mountable, and their special connector treatment makes them well designed for working outdoors.



The FA-GW ½ wave plastic standard whip



The LPA500 directional antenna

Some antennas, such as the LPA500, are directional. This means they radiate greater power in one or more directions, allowing for increased performance and reduced interference. A directional antenna provides greater accuracy than a standard antenna.



The APD4+ antenna distribution unit

Antenna Distribution

If you're working with more than one wireless system, the number of antennas involved quickly multiplies. But rather than using separate antennas for each system, you can often make your antennas do double (or triple, or even quadruple) duty.

Antenna distribution products let a pair of antennas provide signals for multiple receivers. For example, the Electro-Voice APD4+ distributes signals to up to four separate receivers. It's even possible to connect an additional APD4+ to each output pair of a master APD4+ to distribute signals to a total of 16 receivers. So, that would be... 16-tuple duty? Talk about efficiency!

Pro Tip:

If you are choosing antennas for permanent installation, consult with a professional. You can find information and support for EV products through your local EV retailer.

Quick Review

1 You're setting up a wireless microphone system in a meeting room at the Airport Howard Johnson. No matter where you move your antennas, you're still getting a lot of interference. What should you adjust on the receiver?

- **Squelch**

You're near the airport, so you're probably getting a lot of interference from other wireless systems in the area. Increase the squelch to block out the signals you don't want. Don't turn it up too high, though, or you risk blocking the signals you want to receive.



2 You need to set up multiple wireless microphone systems for an outdoor performance. What kind of equipment will make your life easier?

- **Remote-mountable antennas**

All venues are susceptible to RF obstructions, and anything that doesn't allow line of sight from the transmitter to the receiving antennas is not good. Remote-mountable antennas will make it easier for you to place your antennas in the most advantageous locations for clear transmission.

- **Antenna distribution product**

When you're using multiple wireless systems, it's easier to use an antenna distribution product than to set up and adjust separate antennas for each system, especially when you are using upgraded antennas like LPA500s. This way, all of your systems can benefit from a directional antenna and you don't have to buy a pair for each receiver.

- **Frequency coordination software**

In many situations, you can ensure secure operation by running ClearScan on each receiver and syncing the corresponding transmitter. But when working with large quantities of wireless systems, it's best to use software to coordinate the frequencies so you don't run into intermodulation distortion or other interference. That is, unless you just LOVE doing long math problems by hand. Anytime you have multiple systems in use and you aren't sure if they will play well together, contact technical support and they'll help you evaluate the situation and provide a custom frequency coordination if necessary.

Quick Review

- 3** You just found out that your next gig is in a major metropolitan area. You know this area has tons of digital TV stations. What does this mean for your wireless systems?

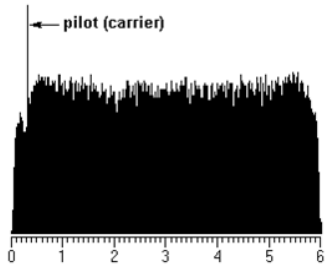

Digital TV signals are bandwidth hogs.

- **Less available bandwidth**
Digital TV signals take up a lot of the bandwidth that wireless microphone systems use, so you might have a hard time finding an available channel. If you're using more than one wireless system, frequency coordination might be particularly tricky. Many users expect the same frequency to work everywhere. But it's a good idea to run ClearScan every time you use a wireless system, just to make certain there aren't new systems in the area that might conflict with yours. This is an absolute necessity when you use the system in a new location! In fact, it's a good idea to run ClearScan periodically to stay clear of new wireless activity in your area.

- 4** Your band has decided to buy a wireless microphone system. Right now, you only need one handheld transmitter, and the lead singer will only use it for a couple of songs. You don't play large venues, and you don't use any other wireless systems. What level system should you get?



The R300-HD, an entry-level wireless microphone system from EV

- **Entry level**
If you only need one wireless channel, there's no need to pay for the additional features you get with more advanced systems—unless you need extra durability because your lead singer is unusually tough on gear! Many entry-level systems from reputable manufacturers offer ClearScan, squelch, and similar features. An entry level system like the EV R300 offers extra value because it incorporates features typically found on high-end systems—such as metal construction and long battery life (typically up to 14 hours.) Plus, you can operate up to seven additional R300 systems when the time comes to expand your wireless use.



Words of Wisdom

There's a right way and a wrong way to do everything... and then there's the way that works in real life. We've collected some tips and best practices from professional audio technicians who are willing to let you to learn from them. (Of course, if you're one of those "have to learn everything the hard way" people, feel free to skip ahead.)

If you're holding the transmitter and can't see the receiving antennas, chances are the antennas can't "see" the transmitter very well either.

Don't remotely mount antennas that aren't made to be remotely mounted. Some antennas need to be mounted to the chassis of the wireless mic. Check with the manufacturer for this information.

Wireless systems need cables from receivers to the mixer, for power supplies to the receivers, and for runs to remote antennae. So while there are fewer visible wires, there are a lot more behind the scenes!

Before you jump into the world of wireless microphones, decide if wireless is really best for your needs. It can be convenient for many applications, but getting wireless systems set up properly can be a challenge—especially in areas where there is a lot of potential interference.



You can't swing a wireless mic around by its cord.

Most mics have a power lockout function. Use it when you hand your mic to someone who is inexperienced, and may decide to fiddle with the switch while they are talking into the mic.

Is it plugged in... is it turned on... are the batteries dead? Change the transmitter batteries regularly. We don't recommend the use of rechargeable batteries but, if you choose to use them, remember that they will not last as long as regular batteries.

Wrap-Up

That's All for Now

Hopefully, we just gave you enough information about wireless microphones to make an educated decision about what you need.

If you need more information or guidance, visit Electro-Voice online at <http://www.electrovoice.com>.

