

ÉPIX

DRIVE 2000 IP

User Manual



Model ID: EPIXDRIVE2000IP

Edition Notes

The ÉPIX Drive 2000 IP User Manual includes a description, safety precautions, installation, programming, operation and maintenance instructions for the ÉPIX Drive 2000 IP as of the release date of this edition.

Trademarks

Chauvet, Chauvet Professional, the Chauvet logo, and ÉPIX are registered trademarks or trademarks of Chauvet & Sons, LLC (d/b/a Chauvet and Chauvet Lighting) in the United States and other countries. Other company and product names and logos referred to herein may be trademarks of their respective companies.

Copyright Notice

The works of authorship contained in this manual, including, but not limited to, all designs, text, and images are owned by Chauvet.

© **Copyright 2023 Chauvet & Sons, LLC. All rights reserved.**

Electronically published by Chauvet in the United States of America.

Manual Use

Chauvet authorizes its customers to download and print this manual for professional information purposes only. Chauvet expressly prohibits the usage, copy, storage, distribution, modification, or printing of this manual or its content for any other purpose without written consent from Chauvet.

Document Printing

For best results, print this document in color, on letter size paper (8.5 x 11 in), double-sided. If using A4 paper (210 x 297 mm), configure the printer to scale the content accordingly.

Intended Audience

Any person installing, operating, and/or maintaining this product should completely read through the guide that shipped with the product, as well as this manual, before installing, operating, or maintaining this product.

Disclaimer

Chauvet believes that the information contained in this manual is accurate in all respects. However, Chauvet assumes no responsibility and specifically disclaims any and all liability to any party for any loss, damage or disruption caused by any errors or omissions in this document, whether such errors or omissions result from negligence, accident or any other cause. Chauvet reserves the right to revise the content of this document without any obligation to notify any person or company of such revision, however, Chauvet has no obligation to make, and does not commit to make, any such revisions. Download the latest version from www.chauvetprofessional.com.

Document Revision

This is revision 6 of the ÉPIX Drive 2000 IP User Manual. Go to www.chauvetprofessional.com for the latest version.

TABLE OF CONTENTS

- 1. Before You Begin** 1
 - What Is Included 1
 - Claims 1
 - Text Conventions 1
 - Symbols 1
 - FCC Statement of Compliance 1
 - Safety Notes..... 2
 - Expected LED Lifespan..... 2
- 2. Introduction** 3
 - Description 3
 - Features 3
 - Product Overview 3
 - Product Dimensions 4
- 3. Setup** 5
 - AC Power 5
 - AC Plug 5
 - Power Linking..... 5
 - Mounting 6
 - Orientation..... 6
 - Rigging 6
 - Procedure..... 6
 - Signal Connections 7
 - Art-Net™ Connection 7
 - sACN Connection..... 7
 - Kling-Net Connection 7
 - Connection Diagram 7
- 4. Operation** 8
 - Control Panel Description 8
 - Home Screen 8
 - Control Panel Lock..... 8
 - Passcode 8
 - Menu Map 8
 - Ethernet Configuration 10
 - Protocol 10
 - Control Personality..... 10
 - Start Universe 10
 - IP Address..... 10
 - DMX Address 10
 - Auto Address..... 11

Control Channel Assignments and Values.....	11
Pixel and 301-CH	11
50-Section	17
25-Section	21
10-Section	22
5-Section	23
8-CH-fixture	24
7-CH-Drive	25
Settings Configuration.....	26
View Linked Fixtures	26
Output Test	26
Display Inverse.....	26
Factory Reset.....	26
Dimmer Curve	26
Software Version	26
Error Messages.....	26
Firmware Update.....	27
Instructions.....	27
Force Upload Instructions	28
5. Maintenance.....	29
Product Maintenance	29
6. Technical Specifications	30
Ordering	31
Contact Us	32
Warranty & Returns.....	32

Before You Begin

1. Before You Begin

What Is Included

- ÉPIX Drive 2000 IP
- Seetronic Powerkon IP65 power cable
- Omega bracket with mounting hardware
- 2 rack ears with screws
- Quick Reference Guide

Claims

Carefully unpack the product immediately and check the container to make sure all the parts are in the package and are in good condition.



If the box or the contents (the product and included accessories) appear damaged from shipping, or show signs of mishandling, notify the carrier immediately, not Chauvet. Failure to report damage to the carrier immediately may invalidate a claim. In addition, keep the box and contents for inspection.

For other issues, such as missing components or parts, damage not related to shipping, or concealed damage, file a claim with Chauvet within 7 days of delivery.

Text Conventions

Convention	Meaning
1–512	A range of values
50/60	A set of values of which only one can be chosen
Settings	A menu option not to be modified
<ENTER>	A key to be pressed on the product's control panel

Symbols

Symbol	Meaning
	Critical installation, configuration, or operation information. Not following these instructions may make the product not work, cause damage to the product, or cause harm to the operator.
	Important installation or configuration information. The product may not function correctly if this information is not used.
	Useful information.



Any reference to data or power connections in this manual assumes the use of Seetronic IP rated cables.

FCC Statement of Compliance

This device complies with Part 15 Part B of the FCC rules. Operation is subject to the following two conditions:

1. This device may not cause harmful interference, and
2. This device must accept any interference received, including interference that may cause undesired operation.

This equipment has been tested and found to comply with the limits for a Class B digital device, pursuant to Part 15 of the FCC Rules. These limits are designed to provide reasonable protection against harmful interference in a residential installation. This equipment generates uses and can radiate radio frequency energy and, if not installed and used in accordance with the instructions, may cause harmful interference to radio communications. However, there is no guarantee that interference will not occur in a particular installation. If this equipment does cause harmful interference to radio or television reception, which can be determined by turning the equipment off and on, the user is encouraged to try to correct the interference by one or more of the following measures:

- Reorient or relocate the receiving antenna.
- Increase the separation between the equipment and receiver.
- Connect the equipment into an outlet on a circuit different from that to which the receiver is connected.
- Consult the dealer or an experienced radio/TV technician for help.

Any changes or modifications not expressly approved by the party responsible for compliance could void the user's authority to operate the equipment.

Safety Notes

Read all the following safety notes before working with this product. These notes contain important information about the installation, usage, and maintenance of this product.



This product contains no user-serviceable parts. Any reference to servicing in this User Manual will only apply to properly trained, certified technicians. Do not open the housing or attempt any repairs.



All applicable local codes and regulations apply to proper installation of this product.

- **CAUTION:**

- This product's housing may be hot when operating. Mount this product in a location with adequate ventilation, at least 20 in (50 cm) from adjacent surfaces.
- When transferring the product from extreme temperature environments, (e.g., cold truck to warm humid ballroom) condensation may form on the internal electronics of the product. To avoid causing a failure, allow the product to fully acclimate to the surrounding environment before connecting it to power.

- **ALWAYS:**

- Disconnect from power before cleaning the product.
- When using an IP65-rated product in an outdoor environment, use IP65- (or higher) rated power and data cable.
- Replace and secure IP-rated protective covers to all power, data, USB, or other ports when not in use.
- Use a safety cable when mounting this product overhead.
- Connect this product to a grounded and protected circuit.

- **DO NOT:**

- Open this product. It contains no user-serviceable parts.
- Leave any flammable material within 50 cm of this product while operating or connected to power.
- Connect this product to a dimmer or rheostat.
- Operate this product if the housing or cables appear damaged.
- Submerge this product (adhere to standards for the published IP rating). Regular outdoor operation is fine.
- Permanently install outdoors in locations with extreme environmental conditions. This includes, but is not limited to:
 - Exposure to a marine/saline environment (within 3 miles of a saltwater body of water).
 - Locations where normal temperatures exceed the temperature ranges in this manual.
 - Locations that are prone to flooding or being buried in snow.
 - Other areas where the product will be subject to extreme radiation or caustic substances.
- The maximum ambient temperature is 113 °F (45 °C). Do not operate this product at higher temperatures.
- The minimum startup temperature is -4°F (-20°C). Do not start the product at lower temperatures.
- The minimum ambient temperature is -22°F (-30°C). Do not operate the product at lower temperatures.
- To eliminate unnecessary wear and improve its lifespan, during periods of non-use completely disconnect the product from power via breaker or by unplugging it.
- In the event of a serious operating problem, stop using immediately.



If a Chauvet product requires service, contact Chauvet Technical Support.

Expected LED Lifespan

Over time, use and heat will gradually reduce LED brightness. Clustered LEDs produce more heat than single LEDs, contributing to shorter lifespans if always used at full intensity. The average LED lifespan is 40,000 to 50,000 hours. To extend LED lifespan, maintain proper ventilation around the product, and limit the overall intensity.

2. Introduction

Description

The ÉPIX Drive 2000 IP hosts the processing and power supply for the ÉPIX IP and ÉPIX Tour product line in one convenient device. Using both ports, it controls up to 20 ÉPIX Strip IP, 40 ÉPIX Strip IP 50, 36 ÉPIX Strip Tour, 72 ÉPIX Strip Tour 50, or 12 ÉPIX Bar Tour products easily using Art-Net™, sACN, or ArKaos Kling-Net. Configuration and setup is fast and easy with its built-in OLED display. Additionally, configuration can be managed with a network-based remote web server.

Features

- The processing and power center of the ÉPIX Tour and IP system will drive any combination of ÉPIX Tour and IP products, up to 2,000 LEDs.
- Versatile control options include Art-Net, Kling-Net, and sACN (streaming ACN) to support the touring/rental/installation markets.
- Quickly and easily configure the ÉPIX Drive 2000 IP using the built-in OLED display and touchscreen menu.
- Easily detect and automatically configure your devices using the auto-address function, regardless of fixture order or type (Bar/Strip/Strip IP).
- Supports up to 20 ÉPIX Strip IP, 36 ÉPIX Strip Tours or 12 ÉPIX Bar Tours.
- Easily daisy chain fixtures directly from the 2 outputs of the ÉPIX Drive 2000 IP.
- Advanced power management design allows you to position the ÉPIX Drive 2000 IP up to 150 ft away from your last fixture (using unshielded cable).
- Works with Arkaos Media Master Express and the Kling-net control protocol for a plug-n-play system that requires almost no training to operate.

Product Overview

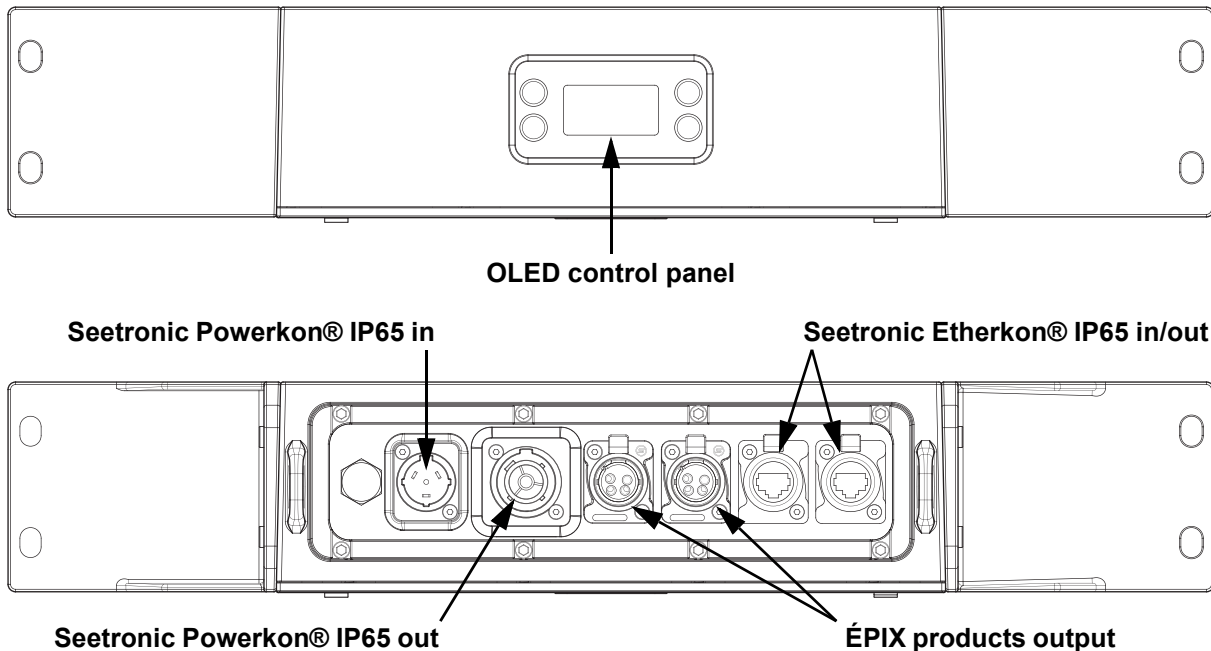

Product Dimensions

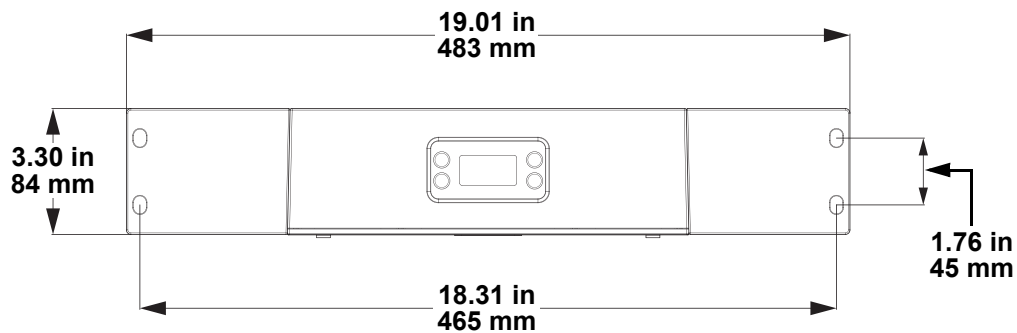
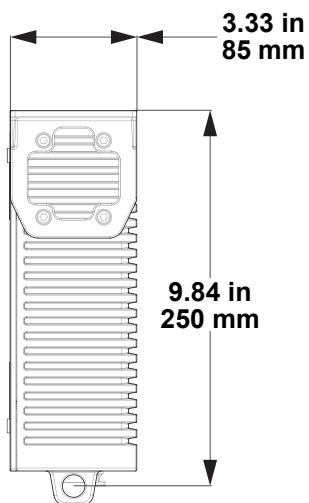
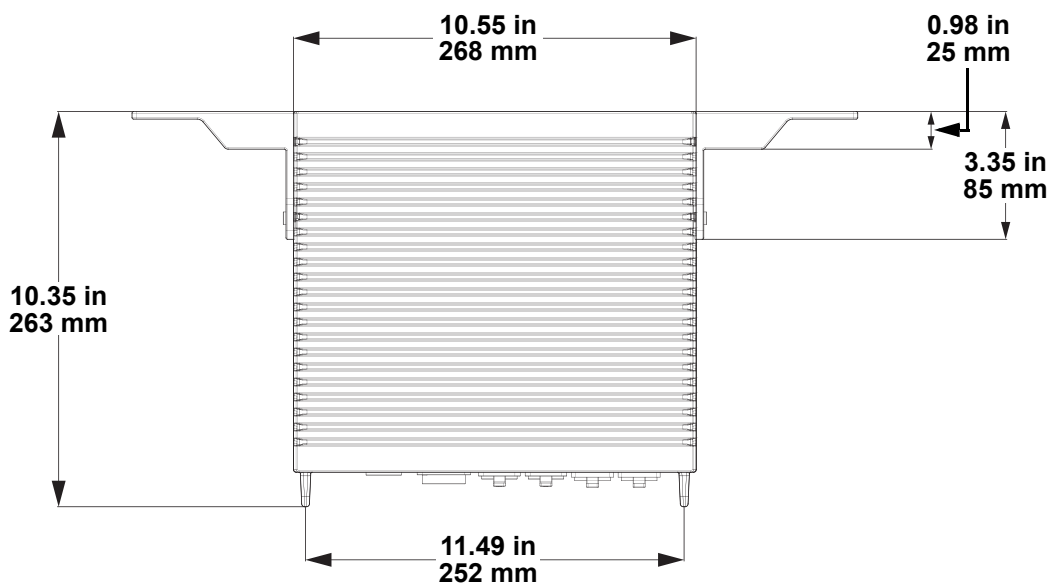

3. Setup

AC Power

The ÉPIX Drive 2000 IP has an auto-ranging power supply and it can work with an input voltage range of 100 to 240 VAC, 50/60 Hz.

To determine the product's power requirements (circuit breaker, power outlet, and wiring), use the current value listed on the label affixed to the product's back panel, or refer to the product's specifications chart. The listed current rating indicates the product's average current draw under normal conditions.



- **Always connect the product to a protected circuit (a circuit breaker or fuse). Make sure the product has an appropriate electrical ground to avoid the risk of electrocution or fire.**
- **To eliminate unnecessary wear and improve its lifespan, during periods of non-use completely disconnect the product from power via breaker or by unplugging it.**



- **Never connect the product to a rheostat (variable resistor) or dimmer circuit, even if the rheostat or dimmer channel serves only as a 0 to 100% switch.**

AC Plug

The ÉPIX Drive 2000 IP comes with a power input cable terminated with a Seetronic Powerkon IP65 connector on one end and an Edison plug on the other end (U.S. market). If necessary, use the table below to wire a new plug.

Connection	Wire (U.S.)	Wire (Europe)	Screw Color
AC Live	Black	Brown	Yellow or Brass
AC Neutral	White	Blue	Silver
AC Ground	Green/Yellow	Green/Yellow	Green

Power Linking

It is possible to power link ÉPIX Drive 2000 IP products. See the table below for the current draw at each voltage and frequency:

	120 V, 60 Hz	208 V, 60 Hz	230 V, 50 Hz
Current Draw	4.68 A	2.69 A	2.5 A

Never exceed 12 A on a single circuit. Power-linking cables can be purchased separately.



- **When using an IP65-rated product in an outdoor environment, use IP65- (or higher) rated power and data cable.**
- **Replace and secure IP-rated protective covers to all power, data, USB, or other ports when not in use.**

Mounting

The ÉPIX Drive 2000 IP fits nicely on a standard 19" rack, sits on a flat level surface, or mounts overhead with the included Omega bracket.

Before mounting the product, read and follow the safety recommendations indicated in the Safety Notes.

Orientation

Always mount this product in a safe position, making sure there is adequate room for ventilation, configuration, and maintenance.

Rigging

Chauvet recommends using the following general guidelines when mounting this product.

- Before deciding on a location for the product, make sure there is easy access to the product for maintenance and programming purposes.
- Make sure that the structure and attachment points can support the weight before hanging the product. See the [Technical Specifications](#) for weight information.
- When mounting the product overhead, always use a safety cable. Mount the product securely to a rigging point, whether an elevated platform or a truss.
- When rigging the product onto a truss, use a mounting clamp of appropriate weight capacity.

Procedure

The ÉPIX Drive 2000 IP comes with an Omega bracket. The user can directly attach a mounting clamp (sold separately) to this Omega bracket. Make sure the clamps are capable of supporting the weight of this product. For the Chauvet Professional line of mounting clamps, go to <http://www.trusst.com/products>.

Mounting Diagram

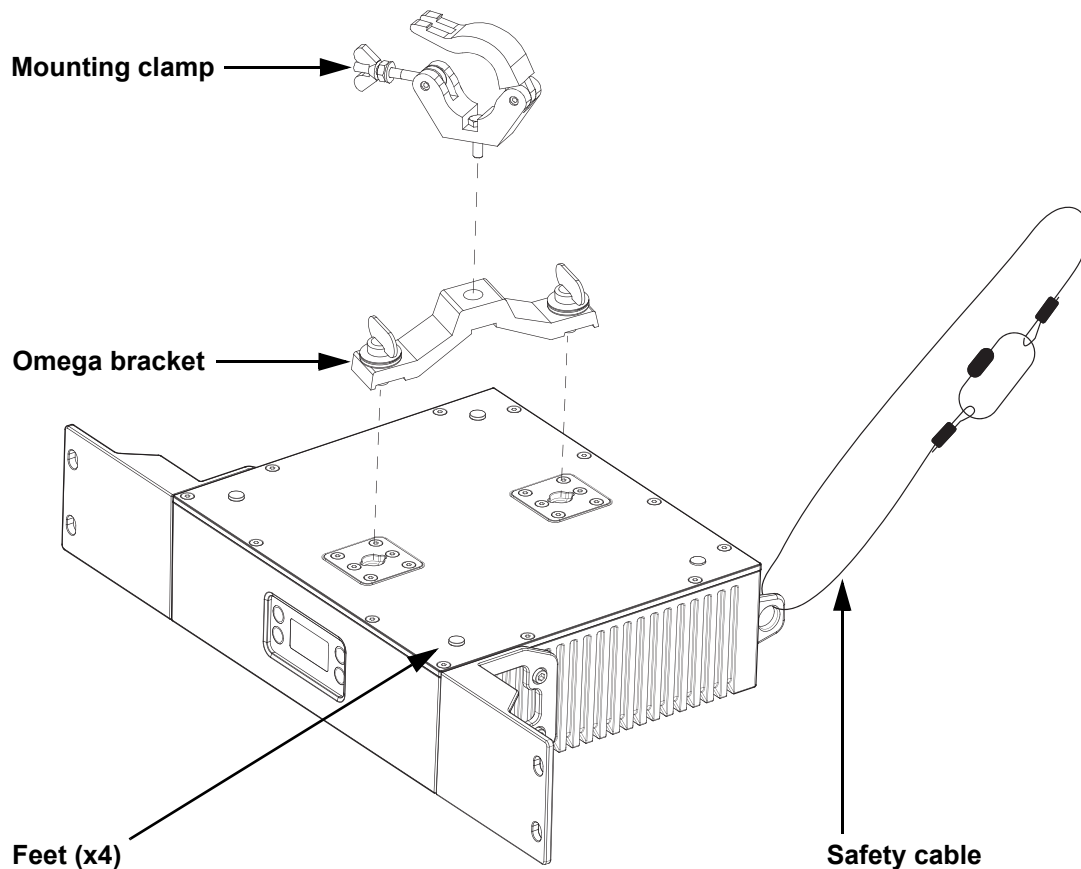

Setup

Signal Connections

The ÉPIX Drive 2000 IP can receive an Art-Net™, sACN, or Kling-Net signal. The ÉPIX Drive 2000 IP has 2 Seetronic Etherkon through ports, and 2 4-pin XLR output ports. If using other compatible products with this product, it is possible to control each individually with a single controller.

Art-Net™ Connection

Art-Net™ is an Ethernet protocol that uses TCP/IP that transfers a large amount of DMX512 data using an Seetronic Etherkon IP65 ethernet connection over a large network. An Art-Net™ protocol document is available from www.chauvetprofessional.com.

Art-Net™ designed by and copyright Artistic Licence Holdings Ltd.

sACN Connection

Also known as ANSI E1.31, streaming ACN is an Ethernet protocol that uses the layering and formatting of Architecture for Control Networks to transport DMX512 data over IP or any other ACN-compatible network.

Kling-Net Connection



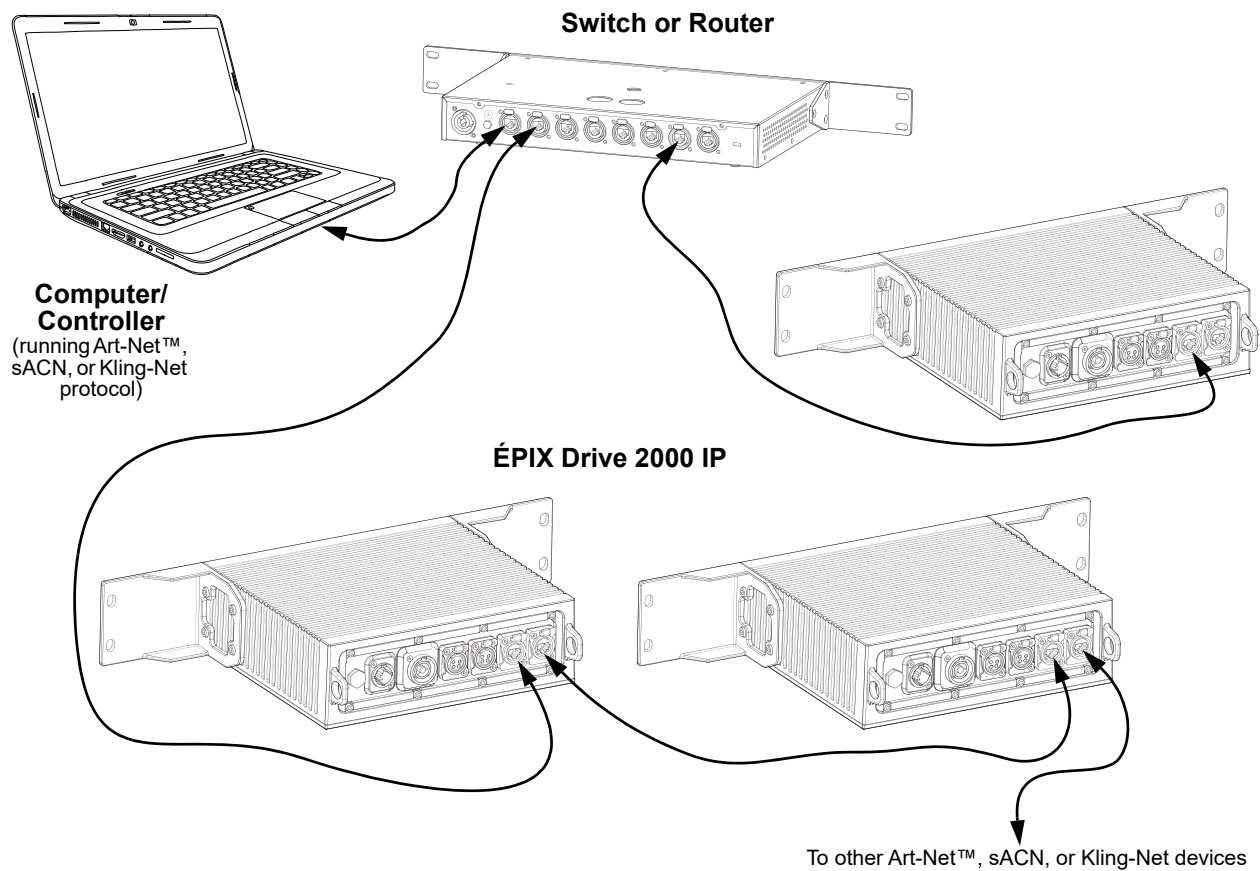

Kling-Net is a network protocol that allows auto configuration of display devices using a Seetronic Etherkon IP65 ethernet connection. Refer to the ArKaos software manual for detailed instructions on programming this product.

Connection Diagram



4. Operation

Control Panel Description

Button	Name	Function
	<LEFT>	Exits from the current menu or function or cycles through the main level of the menu
	<RIGHT>	Enables the currently displayed menu or sets the currently selected value into the selected function
	<UP>	Navigates upwards through the menu list or increases the numeric value when in a function
	<DOWN>	Navigates downwards through the menu list or decreases the numeric value when in a function

Home Screen

The ÉPIX Drive 2000 IP has a home screen that shows the current control protocols, personalities, starting addresses, starting universes, and IP addresses for each port. To see the home screen, hold <LEFT> for three seconds. Use <UP> or <DOWN> to scroll through the current settings. From the home screen, press <LEFT> to reach the main menu.

Control Panel Lock

The setting locks or unlocks the control panel.

1. Go to the **Screen Lock** main level.
2. Select **No** (control panel stays unlocked) or **Yes** (locks control panel).



When the control panel lock is activated, the product will prompt for the passcode in order to access the menu. Enter the passcode as described below.

Passcode

When prompted to enter the passcode, press <UP>, <DOWN>, <UP>, <DOWN>, <RIGHT>.

Menu Map

Refer to the ÉPIX Drive 2000 IP product page on www.chauvetprofessional.com for the latest menu map.

Main Level	Programming Levels		Description	
Auto Address	No		Automatically finds and addresses the products	
	Yes			
View Linked Fixtures	Port A	1. ___ - 18. ___	Displays the connected products	
	Port B			
LED Output	Off		Turns off all LED output	
	Red		Red LEDs at full	
	Green		Green LEDs at full	
	Blue		Blue LEDs at full	
	White		All LEDs at full	
	Fade		Color fade program	
	Scroll		Color scroll program	
Protocol	Port A	Art-Net		Selects the protocol for each port and determines what other menu options are available
		Kling-Net		
		sACN		
	Port B	Art-Net		
		Kling-Net		
		sACN		
Display Inverse	No		Rotates display 180°	
	Yes			

Operation

Main Level	Programming Levels		Description
Factory Reset	No		Resets the product to factory defaults
	Yes		
Port A (Art-Net™ and sACN only)	Personality	Pixel	Sets control personality for Port A
		7-CH-Drive	
		8-CH-fixture	
		5-Section	
		10-Section	
		25-Section	
		50-Section	
Universe	000–246 (Art-Net™) 001–247 (sACN)		Sets the lowest of the 6 consecutive universes to which Port A is assigned
IP Address	IP Address #1–10	1–126 . 0–255 . 0–255 . 0–255	Sets the IP addresses for Port A Note: All IP addresses must be unique
DMX Address	001–_ _ _		Sets the starting address for Port A (highest channel set by Personality)
Port B (Art-Net™ and sACN only)	Personality	Pixel	Sets control personality for Port A
		7-CH-Drive	
		8-CH-fixture	
		5-Section	
		10-Section	
		25-Section	
		50-Section	
Universe	000–246 (Art-Net™) 001–247 (sACN)		Sets the lowest of the 6 consecutive universes to which Port A is assigned
IP Address	IP Address #1–10	1–126 . 0–255 . 0–255 . 0–255	Sets the IP addresses for Port A Note: All IP addresses must be unique
DMX Address	001–_ _ _		Sets the starting address for Port A (highest channel set by Personality)
Screen Lock	No		Locks screen. Passcode: UP, DOWN, UP, DOWN, RIGHT
	Yes		
Dimmer Curve	S Curve		Set the dimmer curve
	Linear		
	Square		
	Inverse Square		
Software Version	Port A:-----V _:_ Port B:-----V _:_		Displays the current software version
Error Messages	-----		Shows if either port is overloaded, or No Errors.

Ethernet Configuration

The ÉPIX Drive 2000 IP operates by routing one of three ethernet protocols (Art-Net™, sACN, or Kling-Net) to the ÉPIX IP and ÉPIX Tour products linked to the outputs of the Drive. The Ethernet protocol must be set for the products to respond correctly to the controller.

Protocol

To configure the protocol for each port of the ÉPIX Drive 2000 IP:

1. Go to the **Protocol** main level.
2. Select from **Port A** or **Port B**.
3. Select the desired protocol, from **Art-Net**, **Kling-Net**, or **sACN**.

Control Personality

The ÉPIX Drive 2000 IP uses Art-Net™ or sACN for its 7 control personalities:

Personality	Channels	Description
Pixel	300 per ÉPIX Strip IP	Complete pixel control
7-CH-Drive	7	Dimmer, auto programs, and strobe
8-CH-fixture	8 per product	Dimmer, auto programs, strobe, and dimmer speed
5-Section	15 per ÉPIX Strip IP	Controls LED output in 5 groups of 20 LEDs
10-Section	30 per ÉPIX Strip IP	Controls LED output in 10 groups of 10 LEDs
25-Section	75 per ÉPIX Strip IP	Controls LED output in 25 groups of 4 LEDs
50-Section	150 per ÉPIX Strip IP	Controls LED output in 50 groups of 2 LEDs
301-CH	301 per ÉPIX Strip IP	Complete pixel control with dimmer

To select the control personality for either port, follow the instructions below:

1. Go to the **Port A** or **Port B** main level.
2. Select the **Personality** option.
3. Select the desired personality, from **Pixel**, **7-CH-Drive**, **8-CH-fixture**, **5-Section**, **10-Section**, **25-Section**, **50-Section**, or **301-CH**.

Start Universe

Each ÉPIX Drive 2000 IP uses 6 consecutive universes in Art-Net™ mode and sACN mode, which are assigned by setting the starting (lowest-numbered) universe address.

To set the starting universe for either port, do the following:

1. Go to the **Port A** or **Port B** main level.
2. Select the **Universe** option.
3. Set the lowest consecutive universe for the selected port, from (Art-Net™) **000–246**, or from (sACN) **001–247**.

IP Address

For each universe of each port on the ÉPIX Drive 2000 IP, there must be a unique IP address. To set these IP addresses for either port, follow the instructions below:

1. Go to the **Port A** or **Port B** main level.
2. Select the **IP Address** option.
3. Select which address to set, from **IP Address #1–10**.
4. Set the first number in the IP address, from **1–126**.
5. Set the second number, from **0–255**.
6. Repeat step 5 for the third and fourth numbers in the IP address.

DMX Address

To set the starting address for either port of the ÉPIX Drive 2000 IP, do the following:

1. Go to the **Port A** or **Port B** main level.
2. Select the **DMX Address** option.
3. Set the starting address for the selected port, from **001–_ _ _**.



Highest address available determined by the [Control Personality](#).

Operation

Auto Address

The ÉPIX Drive 2000 IP addresses connected products with the Auto Address function. To perform an Auto Address, follow the instructions below:

1. Go to the **Auto Address** main level.
2. Select from **No** (do not perform Auto Address) or **Yes** (perform Auto Address).

Control Channel Assignments and Values

Pixel and 301-CH

Pixel	301-CH	Function	Value	Percent
1	1	Red 1	000 ⇄ 255	0–100%
2	2	Green 1	000 ⇄ 255	0–100%
3	3	Blue 1	000 ⇄ 255	0–100%
4	4	Red 2	000 ⇄ 255	0–100%
5	5	Green 2	000 ⇄ 255	0–100%
6	6	Blue 2	000 ⇄ 255	0–100%
7	7	Red 3	000 ⇄ 255	0–100%
8	8	Green 3	000 ⇄ 255	0–100%
9	9	Blue 3	000 ⇄ 255	0–100%
10	10	Red 4	000 ⇄ 255	0–100%
11	11	Green 4	000 ⇄ 255	0–100%
12	12	Blue 4	000 ⇄ 255	0–100%
13	13	Red 5	000 ⇄ 255	0–100%
14	14	Green 5	000 ⇄ 255	0–100%
15	15	Blue 5	000 ⇄ 255	0–100%
16	16	Red 6	000 ⇄ 255	0–100%
17	17	Green 6	000 ⇄ 255	0–100%
18	18	Blue 6	000 ⇄ 255	0–100%
19	19	Red 7	000 ⇄ 255	0–100%
20	20	Green 7	000 ⇄ 255	0–100%
21	21	Blue 7	000 ⇄ 255	0–100%
22	22	Red 8	000 ⇄ 255	0–100%
23	23	Green 8	000 ⇄ 255	0–100%
24	24	Blue 8	000 ⇄ 255	0–100%
25	25	Red 9	000 ⇄ 255	0–100%
26	26	Green 9	000 ⇄ 255	0–100%
27	27	Blue 9	000 ⇄ 255	0–100%
28	28	Red 10	000 ⇄ 255	0–100%
29	29	Green 10	000 ⇄ 255	0–100%
30	30	Blue 10	000 ⇄ 255	0–100%
31	31	Red 11	000 ⇄ 255	0–100%
32	32	Green 11	000 ⇄ 255	0–100%
33	33	Blue 11	000 ⇄ 255	0–100%
34	34	Red 12	000 ⇄ 255	0–100%
35	35	Green 12	000 ⇄ 255	0–100%
36	36	Blue 12	000 ⇄ 255	0–100%
37	37	Red 13	000 ⇄ 255	0–100%
38	38	Green 13	000 ⇄ 255	0–100%
39	39	Blue 13	000 ⇄ 255	0–100%
40	40	Red 14	000 ⇄ 255	0–100%

Pixel	301-CH	Function	Value	Percent
41	41	Green 14	000 ⇄ 255	0–100%
42	42	Blue 14	000 ⇄ 255	0–100%
43	43	Red 15	000 ⇄ 255	0–100%
44	44	Green 15	000 ⇄ 255	0–100%
45	45	Blue 15	000 ⇄ 255	0–100%
46	46	Red 16	000 ⇄ 255	0–100%
47	47	Green 16	000 ⇄ 255	0–100%
48	48	Blue 16	000 ⇄ 255	0–100%
49	49	Red 17	000 ⇄ 255	0–100%
50	50	Green 17	000 ⇄ 255	0–100%
51	51	Blue 17	000 ⇄ 255	0–100%
52	52	Red 18	000 ⇄ 255	0–100%
53	53	Green 18	000 ⇄ 255	0–100%
54	54	Blue 18	000 ⇄ 255	0–100%
55	55	Red 19	000 ⇄ 255	0–100%
56	56	Green 19	000 ⇄ 255	0–100%
57	57	Blue 19	000 ⇄ 255	0–100%
58	58	Red 20	000 ⇄ 255	0–100%
59	59	Green 20	000 ⇄ 255	0–100%
60	60	Blue 20	000 ⇄ 255	0–100%
61	61	Red 21	000 ⇄ 255	0–100%
62	62	Green 21	000 ⇄ 255	0–100%
63	63	Blue 21	000 ⇄ 255	0–100%
64	64	Red 22	000 ⇄ 255	0–100%
65	65	Green 22	000 ⇄ 255	0–100%
66	66	Blue 22	000 ⇄ 255	0–100%
67	67	Red 23	000 ⇄ 255	0–100%
68	68	Green 23	000 ⇄ 255	0–100%
69	69	Blue 23	000 ⇄ 255	0–100%
70	70	Red 24	000 ⇄ 255	0–100%
71	71	Green 24	000 ⇄ 255	0–100%
72	72	Blue 24	000 ⇄ 255	0–100%
73	73	Red 25	000 ⇄ 255	0–100%
74	74	Green 25	000 ⇄ 255	0–100%
75	75	Blue 25	000 ⇄ 255	0–100%
76	76	Red 26	000 ⇄ 255	0–100%
77	77	Green 26	000 ⇄ 255	0–100%
78	78	Blue 26	000 ⇄ 255	0–100%
79	79	Red 27	000 ⇄ 255	0–100%
80	80	Green 27	000 ⇄ 255	0–100%
81	81	Blue 27	000 ⇄ 255	0–100%
82	82	Red 28	000 ⇄ 255	0–100%
83	83	Green 28	000 ⇄ 255	0–100%
84	84	Blue 28	000 ⇄ 255	0–100%
85	85	Red 29	000 ⇄ 255	0–100%
86	86	Green 29	000 ⇄ 255	0–100%
87	87	Blue 29	000 ⇄ 255	0–100%

Pixel	301-CH	Function	Value	Percent
88	88	Red 30	000 ⇄ 255	0–100%
89	89	Green 30	000 ⇄ 255	0–100%
90	90	Blue 30	000 ⇄ 255	0–100%
91	91	Red 31	000 ⇄ 255	0–100%
92	92	Green 31	000 ⇄ 255	0–100%
93	93	Blue 31	000 ⇄ 255	0–100%
94	94	Red 32	000 ⇄ 255	0–100%
95	95	Green 32	000 ⇄ 255	0–100%
96	96	Blue 32	000 ⇄ 255	0–100%
97	97	Red 33	000 ⇄ 255	0–100%
98	98	Green 33	000 ⇄ 255	0–100%
99	99	Blue 33	000 ⇄ 255	0–100%
100	100	Red 34	000 ⇄ 255	0–100%
101	101	Green 34	000 ⇄ 255	0–100%
102	102	Blue 34	000 ⇄ 255	0–100%
103	103	Red 35	000 ⇄ 255	0–100%
104	104	Green 35	000 ⇄ 255	0–100%
105	105	Blue 35	000 ⇄ 255	0–100%
106	106	Red 36	000 ⇄ 255	0–100%
107	107	Green 36	000 ⇄ 255	0–100%
108	108	Blue 36	000 ⇄ 255	0–100%
109	109	Red 37	000 ⇄ 255	0–100%
110	110	Green 37	000 ⇄ 255	0–100%
111	111	Blue 37	000 ⇄ 255	0–100%
112	112	Red 38	000 ⇄ 255	0–100%
113	113	Green 38	000 ⇄ 255	0–100%
114	114	Blue 38	000 ⇄ 255	0–100%
115	115	Red 39	000 ⇄ 255	0–100%
116	116	Green 39	000 ⇄ 255	0–100%
117	117	Blue 39	000 ⇄ 255	0–100%
118	118	Red 40	000 ⇄ 255	0–100%
119	119	Green 40	000 ⇄ 255	0–100%
120	120	Blue 40	000 ⇄ 255	0–100%
121	121	Red 41	000 ⇄ 255	0–100%
122	122	Green 41	000 ⇄ 255	0–100%
123	123	Blue 41	000 ⇄ 255	0–100%
124	124	Red 42	000 ⇄ 255	0–100%
125	125	Green 42	000 ⇄ 255	0–100%
126	126	Blue 42	000 ⇄ 255	0–100%
127	127	Red 43	000 ⇄ 255	0–100%
128	128	Green 43	000 ⇄ 255	0–100%
129	129	Blue 43	000 ⇄ 255	0–100%
130	130	Red 44	000 ⇄ 255	0–100%
131	131	Green 44	000 ⇄ 255	0–100%
132	132	Blue 44	000 ⇄ 255	0–100%
133	133	Red 45	000 ⇄ 255	0–100%
134	134	Green 45	000 ⇄ 255	0–100%

Pixel	301-CH	Function	Value	Percent
135	135	Blue 45	000 ⇄ 255	0–100%
136	136	Red 46	000 ⇄ 255	0–100%
137	137	Green 46	000 ⇄ 255	0–100%
138	138	Blue 46	000 ⇄ 255	0–100%
139	139	Red 47	000 ⇄ 255	0–100%
140	140	Green 47	000 ⇄ 255	0–100%
141	141	Blue 47	000 ⇄ 255	0–100%
142	142	Red 48	000 ⇄ 255	0–100%
143	143	Green 48	000 ⇄ 255	0–100%
144	144	Blue 48	000 ⇄ 255	0–100%
145	145	Red 49	000 ⇄ 255	0–100%
146	146	Green 49	000 ⇄ 255	0–100%
147	147	Blue 49	000 ⇄ 255	0–100%
148	148	Red 50	000 ⇄ 255	0–100%
149	149	Green 50	000 ⇄ 255	0–100%
150	150	Blue 50	000 ⇄ 255	0–100%
151	151	Red 51	000 ⇄ 255	0–100%
152	152	Green 51	000 ⇄ 255	0–100%
153	153	Blue 51	000 ⇄ 255	0–100%
154	154	Red 52	000 ⇄ 255	0–100%
155	155	Green 52	000 ⇄ 255	0–100%
156	156	Blue 52	000 ⇄ 255	0–100%
157	157	Red 53	000 ⇄ 255	0–100%
158	158	Green 53	000 ⇄ 255	0–100%
159	159	Blue 53	000 ⇄ 255	0–100%
160	160	Red 54	000 ⇄ 255	0–100%
161	161	Green 54	000 ⇄ 255	0–100%
162	162	Blue 54	000 ⇄ 255	0–100%
163	163	Red 55	000 ⇄ 255	0–100%
164	164	Green 55	000 ⇄ 255	0–100%
165	165	Blue 55	000 ⇄ 255	0–100%
166	166	Red 56	000 ⇄ 255	0–100%
167	167	Green 56	000 ⇄ 255	0–100%
168	168	Blue 56	000 ⇄ 255	0–100%
169	169	Red 57	000 ⇄ 255	0–100%
170	170	Green 57	000 ⇄ 255	0–100%
171	171	Blue 57	000 ⇄ 255	0–100%
172	172	Red 58	000 ⇄ 255	0–100%
173	173	Green 58	000 ⇄ 255	0–100%
174	174	Blue 58	000 ⇄ 255	0–100%
175	175	Red 59	000 ⇄ 255	0–100%
176	176	Green 59	000 ⇄ 255	0–100%
177	177	Blue 59	000 ⇄ 255	0–100%
178	178	Red 60	000 ⇄ 255	0–100%
179	179	Green 60	000 ⇄ 255	0–100%
180	180	Blue 60	000 ⇄ 255	0–100%
181	181	Red 61	000 ⇄ 255	0–100%

Operation

Pixel	301-CH	Function	Value	Percent
182	182	Green 61	000 ⇄ 255	0–100%
183	183	Blue 61	000 ⇄ 255	0–100%
184	184	Red 62	000 ⇄ 255	0–100%
185	185	Green 62	000 ⇄ 255	0–100%
186	186	Blue 62	000 ⇄ 255	0–100%
187	187	Red 63	000 ⇄ 255	0–100%
188	188	Green 63	000 ⇄ 255	0–100%
189	189	Blue 63	000 ⇄ 255	0–100%
190	190	Red 64	000 ⇄ 255	0–100%
191	191	Green 64	000 ⇄ 255	0–100%
192	192	Blue 64	000 ⇄ 255	0–100%
193	193	Red 65	000 ⇄ 255	0–100%
194	194	Green 65	000 ⇄ 255	0–100%
195	195	Blue 65	000 ⇄ 255	0–100%
196	196	Red 66	000 ⇄ 255	0–100%
197	197	Green 66	000 ⇄ 255	0–100%
198	198	Blue 66	000 ⇄ 255	0–100%
199	199	Red 67	000 ⇄ 255	0–100%
200	200	Green 67	000 ⇄ 255	0–100%
201	201	Blue 67	000 ⇄ 255	0–100%
202	202	Red 68	000 ⇄ 255	0–100%
203	203	Green 68	000 ⇄ 255	0–100%
204	204	Blue 68	000 ⇄ 255	0–100%
205	205	Red 69	000 ⇄ 255	0–100%
206	206	Green 69	000 ⇄ 255	0–100%
207	207	Blue 69	000 ⇄ 255	0–100%
208	208	Red 70	000 ⇄ 255	0–100%
209	209	Green 70	000 ⇄ 255	0–100%
210	210	Blue 70	000 ⇄ 255	0–100%
211	211	Red 71	000 ⇄ 255	0–100%
212	212	Green 71	000 ⇄ 255	0–100%
213	213	Blue 71	000 ⇄ 255	0–100%
214	214	Red 72	000 ⇄ 255	0–100%
215	215	Green 72	000 ⇄ 255	0–100%
216	216	Blue 72	000 ⇄ 255	0–100%
217	217	Red 73	000 ⇄ 255	0–100%
218	218	Green 73	000 ⇄ 255	0–100%
219	219	Blue 73	000 ⇄ 255	0–100%
220	220	Red 74	000 ⇄ 255	0–100%
221	221	Green 74	000 ⇄ 255	0–100%
222	222	Blue 74	000 ⇄ 255	0–100%
223	223	Red 75	000 ⇄ 255	0–100%
224	224	Green 75	000 ⇄ 255	0–100%
225	225	Blue 75	000 ⇄ 255	0–100%
226	226	Red 76	000 ⇄ 255	0–100%
227	227	Green 76	000 ⇄ 255	0–100%
228	228	Blue 76	000 ⇄ 255	0–100%

Pixel	301-CH	Function	Value	Percent
229	229	Red 77	000 ⇄ 255	0–100%
230	230	Green 77	000 ⇄ 255	0–100%
231	231	Blue 77	000 ⇄ 255	0–100%
232	232	Red 78	000 ⇄ 255	0–100%
233	233	Green 78	000 ⇄ 255	0–100%
234	234	Blue 78	000 ⇄ 255	0–100%
235	235	Red 79	000 ⇄ 255	0–100%
236	236	Green 79	000 ⇄ 255	0–100%
237	237	Blue 79	000 ⇄ 255	0–100%
238	238	Red 80	000 ⇄ 255	0–100%
239	239	Green 80	000 ⇄ 255	0–100%
240	240	Blue 80	000 ⇄ 255	0–100%
241	241	Red 81	000 ⇄ 255	0–100%
242	242	Green 81	000 ⇄ 255	0–100%
243	243	Blue 81	000 ⇄ 255	0–100%
244	244	Red 82	000 ⇄ 255	0–100%
245	245	Green 82	000 ⇄ 255	0–100%
246	246	Blue 82	000 ⇄ 255	0–100%
247	247	Red 83	000 ⇄ 255	0–100%
248	248	Green 83	000 ⇄ 255	0–100%
249	249	Blue 83	000 ⇄ 255	0–100%
250	250	Red 84	000 ⇄ 255	0–100%
251	251	Green 84	000 ⇄ 255	0–100%
252	252	Blue 84	000 ⇄ 255	0–100%
253	253	Red 85	000 ⇄ 255	0–100%
254	254	Green 85	000 ⇄ 255	0–100%
255	255	Blue 85	000 ⇄ 255	0–100%
256	256	Red 86	000 ⇄ 255	0–100%
257	257	Green 86	000 ⇄ 255	0–100%
258	258	Blue 86	000 ⇄ 255	0–100%
259	259	Red 87	000 ⇄ 255	0–100%
260	260	Green 87	000 ⇄ 255	0–100%
261	261	Blue 87	000 ⇄ 255	0–100%
262	262	Red 88	000 ⇄ 255	0–100%
263	263	Green 88	000 ⇄ 255	0–100%
264	264	Blue 88	000 ⇄ 255	0–100%
265	265	Red 89	000 ⇄ 255	0–100%
266	266	Green 89	000 ⇄ 255	0–100%
267	267	Blue 89	000 ⇄ 255	0–100%
268	268	Red 90	000 ⇄ 255	0–100%
269	269	Green 90	000 ⇄ 255	0–100%
270	270	Blue 90	000 ⇄ 255	0–100%
271	271	Red 91	000 ⇄ 255	0–100%
272	272	Green 91	000 ⇄ 255	0–100%
273	273	Blue 91	000 ⇄ 255	0–100%
274	274	Red 92	000 ⇄ 255	0–100%
275	275	Green 92	000 ⇄ 255	0–100%

Operation

Pixel	301-CH	Function	Value	Percent
276	276	Blue 92	000 ⇔ 255	0–100%
277	277	Red 93	000 ⇔ 255	0–100%
278	278	Green 93	000 ⇔ 255	0–100%
279	279	Blue 93	000 ⇔ 255	0–100%
280	280	Red 94	000 ⇔ 255	0–100%
281	281	Green 94	000 ⇔ 255	0–100%
282	282	Blue 94	000 ⇔ 255	0–100%
283	283	Red 95	000 ⇔ 255	0–100%
284	284	Green 95	000 ⇔ 255	0–100%
285	285	Blue 95	000 ⇔ 255	0–100%
286	286	Red 96	000 ⇔ 255	0–100%
287	287	Green 96	000 ⇔ 255	0–100%
288	288	Blue 96	000 ⇔ 255	0–100%
289	289	Red 97	000 ⇔ 255	0–100%
290	290	Green 97	000 ⇔ 255	0–100%
291	291	Blue 97	000 ⇔ 255	0–100%
292	292	Red 98	000 ⇔ 255	0–100%
293	293	Green 98	000 ⇔ 255	0–100%
294	294	Blue 98	000 ⇔ 255	0–100%
295	295	Red 99	000 ⇔ 255	0–100%
296	296	Green 99	000 ⇔ 255	0–100%
297	297	Blue 99	000 ⇔ 255	0–100%
298	298	Red 100	000 ⇔ 255	0–100%
299	299	Green 100	000 ⇔ 255	0–100%
300	300	Blue 100	000 ⇔ 255	0–100%
–	301	Dimmer	000 ⇔ 255	0–100%

50-Section

150 channels per ÉPIX Strip IP

Channel	Function	Value	Percent
1	Red 1–2	000 ⇔ 255	0–100%
2	Green 1–2	000 ⇔ 255	0–100%
3	Blue 1–2	000 ⇔ 255	0–100%
4	Red 3–4	000 ⇔ 255	0–100%
5	Green 3–4	000 ⇔ 255	0–100%
6	Blue 3–4	000 ⇔ 255	0–100%
7	Red 5–6	000 ⇔ 255	0–100%
8	Green 5–6	000 ⇔ 255	0–100%
9	Blue 5–6	000 ⇔ 255	0–100%
10	Red 7–8	000 ⇔ 255	0–100%
11	Green 7–8	000 ⇔ 255	0–100%
12	Blue 7–8	000 ⇔ 255	0–100%
13	Red 9–10	000 ⇔ 255	0–100%
14	Green 9–10	000 ⇔ 255	0–100%
15	Blue 9–10	000 ⇔ 255	0–100%
16	Red 11–12	000 ⇔ 255	0–100%

Channel	Function	Value	Percent
17	Green 11–12	000 ⇄ 255	0–100%
18	Blue 11–12	000 ⇄ 255	0–100%
19	Red 13–14	000 ⇄ 255	0–100%
20	Green 13–14	000 ⇄ 255	0–100%
21	Blue 13–14	000 ⇄ 255	0–100%
22	Red 15–16	000 ⇄ 255	0–100%
23	Green 15–16	000 ⇄ 255	0–100%
24	Blue 15–16	000 ⇄ 255	0–100%
25	Red 17–18	000 ⇄ 255	0–100%
26	Green 17–18	000 ⇄ 255	0–100%
27	Blue 17–18	000 ⇄ 255	0–100%
28	Red 19–20	000 ⇄ 255	0–100%
29	Green 19–20	000 ⇄ 255	0–100%
30	Blue 19–20	000 ⇄ 255	0–100%
31	Red 21–22	000 ⇄ 255	0–100%
32	Green 21–22	000 ⇄ 255	0–100%
33	Blue 21–22	000 ⇄ 255	0–100%
34	Red 23–24	000 ⇄ 255	0–100%
35	Green 23–24	000 ⇄ 255	0–100%
36	Blue 23–24	000 ⇄ 255	0–100%
37	Red 25–26	000 ⇄ 255	0–100%
38	Green 25–26	000 ⇄ 255	0–100%
39	Blue 25–26	000 ⇄ 255	0–100%
40	Red 27–28	000 ⇄ 255	0–100%
41	Green 27–28	000 ⇄ 255	0–100%
42	Blue 27–28	000 ⇄ 255	0–100%
43	Red 29–30	000 ⇄ 255	0–100%
44	Green 29–30	000 ⇄ 255	0–100%
45	Blue 29–30	000 ⇄ 255	0–100%
46	Red 31–32	000 ⇄ 255	0–100%
47	Green 31–32	000 ⇄ 255	0–100%
48	Blue 31–32	000 ⇄ 255	0–100%
49	Red 33–34	000 ⇄ 255	0–100%
50	Green 33–34	000 ⇄ 255	0–100%
51	Blue 33–34	000 ⇄ 255	0–100%
52	Red 35–36	000 ⇄ 255	0–100%
53	Green 35–36	000 ⇄ 255	0–100%
54	Blue 35–36	000 ⇄ 255	0–100%
55	Red 37–38	000 ⇄ 255	0–100%
56	Green 37–38	000 ⇄ 255	0–100%
57	Blue 37–38	000 ⇄ 255	0–100%
58	Red 39–40	000 ⇄ 255	0–100%
59	Green 39–40	000 ⇄ 255	0–100%
60	Blue 39–40	000 ⇄ 255	0–100%
61	Red 41–42	000 ⇄ 255	0–100%
62	Green 41–42	000 ⇄ 255	0–100%
63	Blue 41–42	000 ⇄ 255	0–100%

Operation

Channel	Function	Value	Percent
64	Red 43–44	000 ⇔ 255	0–100%
65	Green 43–44	000 ⇔ 255	0–100%
66	Blue 43–44	000 ⇔ 255	0–100%
67	Red 45–46	000 ⇔ 255	0–100%
68	Green 45–46	000 ⇔ 255	0–100%
69	Blue 45–46	000 ⇔ 255	0–100%
70	Red 47–48	000 ⇔ 255	0–100%
71	Green 47–48	000 ⇔ 255	0–100%
72	Blue 47–48	000 ⇔ 255	0–100%
73	Red 49–50	000 ⇔ 255	0–100%
74	Green 49–50	000 ⇔ 255	0–100%
75	Blue 49–50	000 ⇔ 255	0–100%
76	Red 51–52	000 ⇔ 255	0–100%
77	Green 51–52	000 ⇔ 255	0–100%
78	Blue 51–52	000 ⇔ 255	0–100%
79	Red 53–54	000 ⇔ 255	0–100%
80	Green 53–54	000 ⇔ 255	0–100%
81	Blue 53–54	000 ⇔ 255	0–100%
82	Red 55–56	000 ⇔ 255	0–100%
83	Green 55–56	000 ⇔ 255	0–100%
84	Blue 55–56	000 ⇔ 255	0–100%
85	Red 57–58	000 ⇔ 255	0–100%
86	Green 57–58	000 ⇔ 255	0–100%
87	Blue 57–58	000 ⇔ 255	0–100%
88	Red 59–60	000 ⇔ 255	0–100%
89	Green 59–60	000 ⇔ 255	0–100%
90	Blue 59–60	000 ⇔ 255	0–100%
91	Red 61–62	000 ⇔ 255	0–100%
92	Green 61–62	000 ⇔ 255	0–100%
93	Blue 61–62	000 ⇔ 255	0–100%
94	Red 63–64	000 ⇔ 255	0–100%
95	Green 63–64	000 ⇔ 255	0–100%
96	Blue 63–64	000 ⇔ 255	0–100%
97	Red 65–66	000 ⇔ 255	0–100%
98	Green 65–66	000 ⇔ 255	0–100%
99	Blue 65–66	000 ⇔ 255	0–100%
100	Red 67–68	000 ⇔ 255	0–100%
101	Green 67–68	000 ⇔ 255	0–100%
102	Blue 67–68	000 ⇔ 255	0–100%
103	Red 69–70	000 ⇔ 255	0–100%
104	Green 69–70	000 ⇔ 255	0–100%
105	Blue 69–70	000 ⇔ 255	0–100%
106	Red 71–72	000 ⇔ 255	0–100%
107	Green 71–72	000 ⇔ 255	0–100%
108	Blue 71–72	000 ⇔ 255	0–100%
109	Red 73–74	000 ⇔ 255	0–100%
110	Green 73–74	000 ⇔ 255	0–100%

Channel	Function	Value	Percent
111	Blue 73–74	000 ⇄ 255	0–100%
112	Red 75–76	000 ⇄ 255	0–100%
113	Green 75–76	000 ⇄ 255	0–100%
114	Blue 75–76	000 ⇄ 255	0–100%
115	Red 77–78	000 ⇄ 255	0–100%
116	Green 77–78	000 ⇄ 255	0–100%
117	Blue 77–78	000 ⇄ 255	0–100%
118	Red 79–80	000 ⇄ 255	0–100%
119	Green 79–80	000 ⇄ 255	0–100%
120	Blue 79–80	000 ⇄ 255	0–100%
121	Red 81–82	000 ⇄ 255	0–100%
122	Green 81–82	000 ⇄ 255	0–100%
123	Blue 81–82	000 ⇄ 255	0–100%
124	Red 83–84	000 ⇄ 255	0–100%
125	Green 83–84	000 ⇄ 255	0–100%
126	Blue 83–84	000 ⇄ 255	0–100%
127	Red 85–86	000 ⇄ 255	0–100%
128	Green 85–86	000 ⇄ 255	0–100%
129	Blue 85–86	000 ⇄ 255	0–100%
130	Red 87–88	000 ⇄ 255	0–100%
131	Green 87–88	000 ⇄ 255	0–100%
132	Blue 87–88	000 ⇄ 255	0–100%
133	Red 89–90	000 ⇄ 255	0–100%
134	Green 89–90	000 ⇄ 255	0–100%
135	Blue 89–90	000 ⇄ 255	0–100%
136	Red 91–92	000 ⇄ 255	0–100%
137	Green 91–92	000 ⇄ 255	0–100%
138	Blue 91–92	000 ⇄ 255	0–100%
139	Red 93–94	000 ⇄ 255	0–100%
140	Green 93–94	000 ⇄ 255	0–100%
141	Blue 93–94	000 ⇄ 255	0–100%
142	Red 95–96	000 ⇄ 255	0–100%
143	Green 95–96	000 ⇄ 255	0–100%
144	Blue 95–96	000 ⇄ 255	0–100%
145	Red 97–98	000 ⇄ 255	0–100%
146	Green 97–98	000 ⇄ 255	0–100%
147	Blue 97–98	000 ⇄ 255	0–100%
148	Red 99–100	000 ⇄ 255	0–100%
149	Green 99–100	000 ⇄ 255	0–100%
150	Blue 99–100	000 ⇄ 255	0–100%

Operation

25-Section

75 channels per ÉPIX Strip IP

Channel	Function	Value	Percent
1	Red 1–4	000 ⇔ 255	0–100%
2	Green 1–4	000 ⇔ 255	0–100%
3	Blue 1–4	000 ⇔ 255	0–100%
4	Red 5–8	000 ⇔ 255	0–100%
5	Green 5–8	000 ⇔ 255	0–100%
6	Blue 5–8	000 ⇔ 255	0–100%
7	Red 9–12	000 ⇔ 255	0–100%
8	Green 9–12	000 ⇔ 255	0–100%
9	Blue 9–12	000 ⇔ 255	0–100%
10	Red 13–16	000 ⇔ 255	0–100%
11	Green 13–16	000 ⇔ 255	0–100%
12	Blue 13–16	000 ⇔ 255	0–100%
13	Red 17–20	000 ⇔ 255	0–100%
14	Green 17–20	000 ⇔ 255	0–100%
15	Blue 17–20	000 ⇔ 255	0–100%
16	Red 21–24	000 ⇔ 255	0–100%
17	Green 21–24	000 ⇔ 255	0–100%
18	Blue 21–24	000 ⇔ 255	0–100%
19	Red 25–28	000 ⇔ 255	0–100%
20	Green 25–28	000 ⇔ 255	0–100%
21	Blue 25–28	000 ⇔ 255	0–100%
22	Red 29–32	000 ⇔ 255	0–100%
23	Green 29–32	000 ⇔ 255	0–100%
24	Blue 29–32	000 ⇔ 255	0–100%
25	Red 33–36	000 ⇔ 255	0–100%
26	Green 33–36	000 ⇔ 255	0–100%
27	Blue 33–36	000 ⇔ 255	0–100%
28	Red 37–40	000 ⇔ 255	0–100%
29	Green 37–40	000 ⇔ 255	0–100%
30	Blue 37–40	000 ⇔ 255	0–100%
31	Red 41–44	000 ⇔ 255	0–100%
32	Green 41–44	000 ⇔ 255	0–100%
33	Blue 41–44	000 ⇔ 255	0–100%
34	Red 45–48	000 ⇔ 255	0–100%
35	Green 45–48	000 ⇔ 255	0–100%
36	Blue 45–48	000 ⇔ 255	0–100%
37	Red 49–52	000 ⇔ 255	0–100%
38	Green 49–52	000 ⇔ 255	0–100%
39	Blue 49–52	000 ⇔ 255	0–100%
40	Red 53–56	000 ⇔ 255	0–100%
41	Green 53–56	000 ⇔ 255	0–100%
42	Blue 53–56	000 ⇔ 255	0–100%
43	Red 57–60	000 ⇔ 255	0–100%
44	Green 57–60	000 ⇔ 255	0–100%
45	Blue 57–60	000 ⇔ 255	0–100%

Channel	Function	Value	Percent
46	Red 61–64	000 ⇄ 255	0–100%
47	Green 61–64	000 ⇄ 255	0–100%
48	Blue 61–64	000 ⇄ 255	0–100%
49	Red 65–68	000 ⇄ 255	0–100%
50	Green 65–68	000 ⇄ 255	0–100%
51	Blue 65–68	000 ⇄ 255	0–100%
52	Red 69–72	000 ⇄ 255	0–100%
53	Green 69–72	000 ⇄ 255	0–100%
54	Blue 69–72	000 ⇄ 255	0–100%
55	Red 73–76	000 ⇄ 255	0–100%
56	Green 73–76	000 ⇄ 255	0–100%
57	Blue 73–76	000 ⇄ 255	0–100%
58	Red 77–80	000 ⇄ 255	0–100%
59	Green 77–80	000 ⇄ 255	0–100%
60	Blue 77–80	000 ⇄ 255	0–100%
61	Red 81–84	000 ⇄ 255	0–100%
62	Green 81–84	000 ⇄ 255	0–100%
63	Blue 81–84	000 ⇄ 255	0–100%
64	Red 85–88	000 ⇄ 255	0–100%
65	Green 85–88	000 ⇄ 255	0–100%
66	Blue 85–88	000 ⇄ 255	0–100%
67	Red 89–92	000 ⇄ 255	0–100%
68	Green 89–92	000 ⇄ 255	0–100%
69	Blue 89–92	000 ⇄ 255	0–100%
70	Red 93–96	000 ⇄ 255	0–100%
71	Green 93–96	000 ⇄ 255	0–100%
72	Blue 93–96	000 ⇄ 255	0–100%
73	Red 97–100	000 ⇄ 255	0–100%
74	Green 97–100	000 ⇄ 255	0–100%
75	Blue 97–100	000 ⇄ 255	0–100%

10-Section

30 channels per ÉPIX Strip IP

Channel	Function	Value	Percent
1	Red 1–10	000 ⇄ 255	0–100%
2	Green 1–10	000 ⇄ 255	0–100%
3	Blue 1–10	000 ⇄ 255	0–100%
4	Red 11–20	000 ⇄ 255	0–100%
5	Green 11–20	000 ⇄ 255	0–100%
6	Blue 11–20	000 ⇄ 255	0–100%
7	Red 21–30	000 ⇄ 255	0–100%
8	Green 21–30	000 ⇄ 255	0–100%
9	Blue 21–30	000 ⇄ 255	0–100%
10	Red 31–40	000 ⇄ 255	0–100%
11	Green 31–40	000 ⇄ 255	0–100%
12	Blue 31–40	000 ⇄ 255	0–100%

Operation

Channel	Function	Value	Percent
13	Red 41–50	000 ⇄ 255	0–100%
14	Green 41–50	000 ⇄ 255	0–100%
15	Blue 41–50	000 ⇄ 255	0–100%
16	Red 51–60	000 ⇄ 255	0–100%
17	Green 51–60	000 ⇄ 255	0–100%
18	Blue 51–60	000 ⇄ 255	0–100%
19	Red 61–70	000 ⇄ 255	0–100%
20	Green 61–70	000 ⇄ 255	0–100%
21	Blue 61–70	000 ⇄ 255	0–100%
22	Red 71–80	000 ⇄ 255	0–100%
23	Green 71–80	000 ⇄ 255	0–100%
24	Blue 71–80	000 ⇄ 255	0–100%
25	Red 81–90	000 ⇄ 255	0–100%
26	Green 81–90	000 ⇄ 255	0–100%
27	Blue 81–90	000 ⇄ 255	0–100%
28	Red 91–100	000 ⇄ 255	0–100%
29	Green 91–100	000 ⇄ 255	0–100%
30	Blue 91–100	000 ⇄ 255	0–100%

5-Section

15 channels per ÉPIX Strip IP

Channel	Function	Value	Percent
1	Red 1–20	000 ⇄ 255	0–100%
2	Green 1–20	000 ⇄ 255	0–100%
3	Blue 1–20	000 ⇄ 255	0–100%
4	Red 21–40	000 ⇄ 255	0–100%
5	Green 21–40	000 ⇄ 255	0–100%
6	Blue 21–40	000 ⇄ 255	0–100%
7	Red 41–60	000 ⇄ 255	0–100%
8	Green 41–60	000 ⇄ 255	0–100%
9	Blue 41–60	000 ⇄ 255	0–100%
10	Red 61–80	000 ⇄ 255	0–100%
11	Green 61–80	000 ⇄ 255	0–100%
12	Blue 61–80	000 ⇄ 255	0–100%
13	Red 81–100	000 ⇄ 255	0–100%
14	Green 81–100	000 ⇄ 255	0–100%
15	Blue 81–100	000 ⇄ 255	0–100%

8-CH-fixture

8 channels per ÉPIX Strip IP

Channel	Function	Value	Percent
1	Dimmer	000 ⇔ 255	0–100%
2	Red	000 ⇔ 255	0–100%
3	Green	000 ⇔ 255	0–100%
4	Blue	000 ⇔ 255	0–100%
5	Auto program	000 ⇔ 010	No function
		011 ⇔ 024	Auto program 1
		025 ⇔ 038	Auto program 2
		039 ⇔ 051	Auto program 3
		052 ⇔ 065	Auto program 4
		066 ⇔ 078	Auto program 5
		079 ⇔ 092	Auto program 6
		092 ⇔ 105	Auto program 7
		106 ⇔ 119	Auto program 8
		120 ⇔ 133	Auto program 9
		134 ⇔ 146	Auto program 10
		147 ⇔ 160	Auto program 11
		161 ⇔ 173	Auto program 12
		174 ⇔ 187	Auto program 13
		188 ⇔ 200	Auto program 14
		201 ⇔ 214	Auto program 15
		215 ⇔ 227	Auto program 16
228 ⇔ 241	Auto program 17		
		242 ⇔ 255	Cycle auto programs 1–17
6	Speed	000 ⇔ 255	0–100%
7	Strobe	000 ⇔ 010	No function
		011 ⇔ 255	Strobe, slow to fast
8	Dimmer speed mode	000 ⇔ 101	Linear dimmer
		102 ⇔ 152	Fast dimmer
		153 ⇔ 203	Medium dimmer
		204 ⇔ 255	Slow dimmer

Operation

7-CH-Drive

7 channels per ÉPIX Drive 2000 IP

Channel	Function	Value	Percent
1	Dimmer	000 ⇔ 255	0–100%
2	Red	000 ⇔ 255	0–100%
3	Green	000 ⇔ 255	0–100%
4	Blue	000 ⇔ 255	0–100%
5	Auto program	000 ⇔ 010	No function
		011 ⇔ 024	Auto program 1
		025 ⇔ 038	Auto program 2
		039 ⇔ 051	Auto program 3
		052 ⇔ 065	Auto program 4
		066 ⇔ 078	Auto program 5
		079 ⇔ 092	Auto program 6
		092 ⇔ 105	Auto program 7
		106 ⇔ 119	Auto program 8
		120 ⇔ 133	Auto program 9
		134 ⇔ 146	Auto program 10
		147 ⇔ 160	Auto program 11
		161 ⇔ 173	Auto program 12
		174 ⇔ 187	Auto program 13
		188 ⇔ 200	Auto program 14
		201 ⇔ 214	Auto program 15
		215 ⇔ 227	Auto program 16
228 ⇔ 241	Auto program 17		
		242 ⇔ 255	Cycle auto programs 1–17
6	Speed	000 ⇔ 255	0–100%
7	Strobe	000 ⇔ 010	No function
		011 ⇔ 255	Strobe, slow to fast

Settings Configuration

View Linked Fixtures

To view which fixtures are linked in order from each port:

1. Go to the **View Linked Fixtures** main level.
2. Select from **Port A** or **Port B**.
3. Use **<UP>** or **<DOWN>** to scroll through the list of linked fixtures for the selected port.

Output Test

To test the output of the LEDs of all connected ÉPIX products:

1. Go to the **LED Output** main level.
2. Select from **Off** (no LED output), **Red** (red LEDs at maximum), **Green** (green LEDs at maximum), **Blue** (blue LEDs at maximum), **White** (all LEDs at maximum), **Fade** (color fade program), or **Scroll** (color scroll program).

Display Inverse

To flip the display of the ÉPIX Drive 2000 IP 180°, press **<LEFT>** and **<RIGHT>** together, or do the following:

1. Go to the **Display Inverse** main level.
2. Select from **No** (normal display) or **Yes** (inverted display).

Factory Reset

To reset the ÉPIX Drive 2000 IP to factory default settings:

1. Go to the **Factory Reset** main level.
2. Select from **No** (do not factory reset) or **Yes** (reset to factory defaults).

Dimmer Curve

To set the dimmer curve:

1. Go to the **Dimmer Curve** main level.
2. Select from **S Curve**, **Linear**, **Square**, or **Inverse Square**.

Software Version

To view the current software version for both ports, follow the instructions below:

1. Press **<LEFT>** repeatedly until **Software Version** is selected.
2. Press **<RIGHT>**.

Error Messages

To see any current error messages:

1. Go to the **Error Messages** main level.
2. The error message(s) will show on the display, such as "**Port A overloaded !**". If there is no error message, "**No Errors.**" will show on the display.

Operation

Firmware Update

On occasion, updates to the firmware for the ÉPIX Drive 2000 IP will be made available. The following is the procedure for obtaining and installing these updates on a Windows PC.

Instructions

1. Download the CHAUVET Professional Uploader from <http://www.chauvetprofessional.com/products/epix-drive-2000-ip> and install it.
2. Download the latest firmware update from <http://www.chauvetprofessional.com/products/epix-drive-2000-ip>.
 - After downloading the software and update file, disable or disconnect any networks the PC is connected to. Do NOT disable the network created when the ÉPIX Drive 2000 IP is connected in the next step.
3. Power on the ÉPIX Drive 2000 IP and connect it to the computer using an ethernet cable.
4. Open the ÉPIX Drive 2000 IP upload software.
5. Use the **Browse** option to select the latest firmware update to upload.
 - Note:** ALWAYS upload the **B** file before the **A** file.
6. Click **Next**.
7. Click **Find Compatible Devices**.
8. Click **Next** when the software indicates a device has been found.
 - If the software cannot find the ÉPIX Drive 2000 IP on the network, see [Force Upload Instructions](#).
9. Select the check-box next to ÉPIX Drive 2000 B or ÉPIX Drive 2000 A. (Always upload the **B** file before the **A** file.)
10. Click **Upload Firmware**.
11. Wait for the upload to complete. Do NOT disconnect or power off the product during this process.
12. When the status field says **Done**, exit out of the upload software.
13. Restart from step 4, uploading the **A** file this time. After uploading the **A** file, skip this step.
14. Disconnect the ÉPIX Drive 2000 IP from the computer. The firmware update is complete.

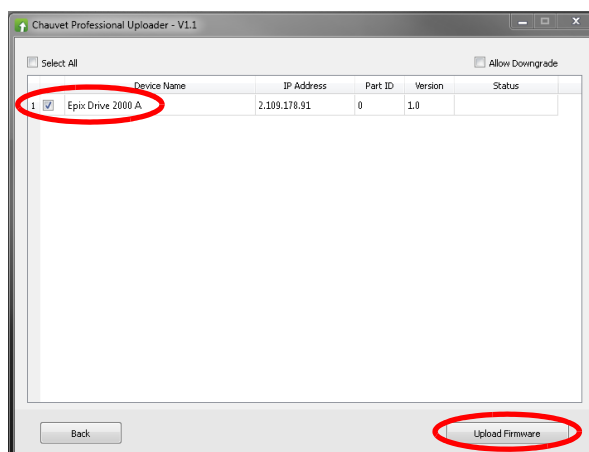
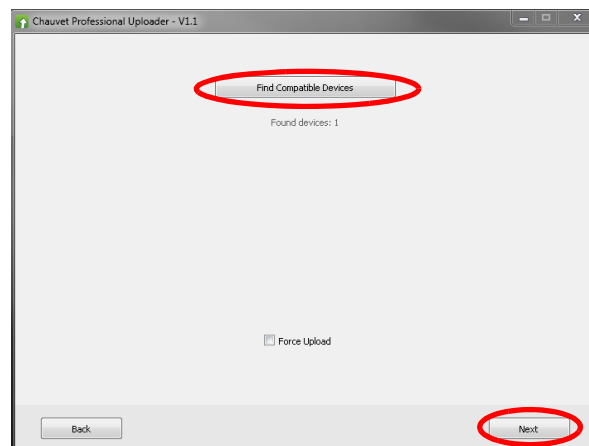
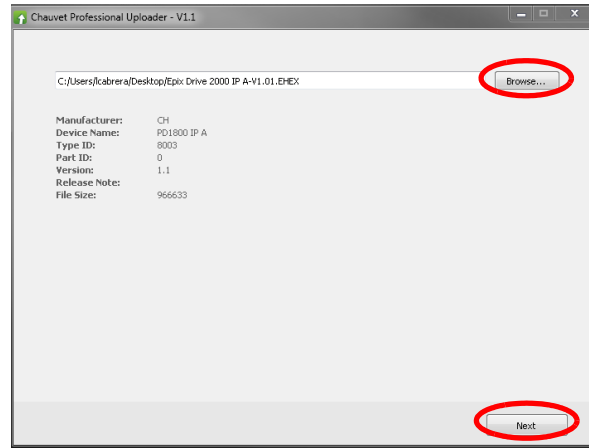

Force Upload Instructions

In the event that the upload software cannot find the ÉPIX Drive 2000 IP on the network, or if the display on the product is black when powered on, follow the instructions below.

1. Set the IP address of the network on the PC to 192.168.1.24, and the subnet to 255.255.255.0.
2. Turn off the ÉPIX Drive 2000 IP. Turn it back on and immediately press and hold **<LEFT>** and **<RIGHT>**. A green LED above the display menu will flash, indicating the product is in Force Upload mode.
3. After selecting the firmware update file (Always upload the **B** file before the **A** file!) and continuing to the **Find Compatible Devices** page, check off the **Force Upload** option.
4. Click **Next**.
5. Click **Upload Firmware**.

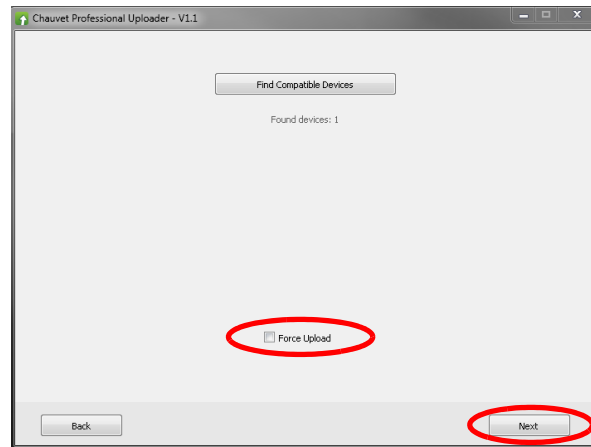

6. Wait for the upload to complete. Do NOT disconnect or power off the product during this process.
7. When the upload is complete, exit out of the upload software.
8. Restart from step 2, turning the product off and back on again in Force Upload mode, restarting the upload software, and selecting the **A** file this time. After uploading the **A** file, skip this step.
9. Disconnect the ÉPIX Drive 2000 IP from the computer. The firmware update is complete.

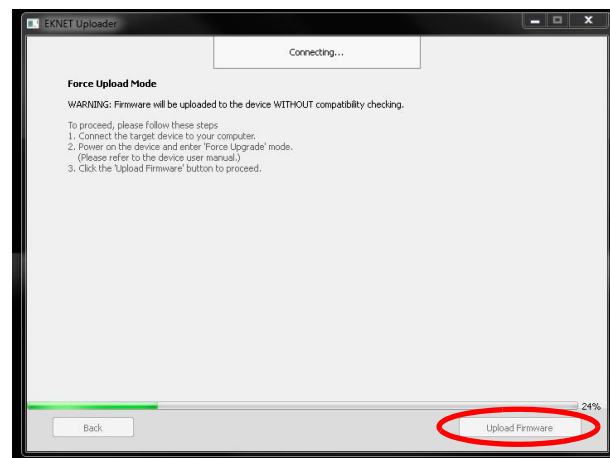

In the event that the [Software Version](#) section of the menu lists **V0.0** for **Port B**, do the following:

1. Follow steps 1 through 3 in the [Instructions](#) under [Firmware Update](#).
2. Press and hold **<RIGHT>** on the ÉPIX Drive 2000 IP until **Force Upload!** shows on the display.
3. Open the ÉPIX Drive 2000 IP upload software.
4. Use the **Browse** option and select the **B** file.
5. Click **Next**.
6. Check off the **Force Upload** option and click **Next**.
7. Click **Upload Firmware**.
8. Wait for the upload to complete. Do NOT disconnect or power off the product during this process.
9. When the upload is complete, exit out of the upload software.

5. Maintenance

Product Maintenance

Dust build-up reduces light output performance and can cause overheating. This can lead to reduction of the light source's life and/or mechanical wear. To maintain optimum performance and minimize wear, clean each lighting product at least twice a month. However, be aware that usage and environmental conditions could be contributing factors to increase the cleaning frequency.

To clean the product, follow the instructions below:

1. Unplug the product from power.
2. Wait until the product is at room temperature.
3. Use a vacuum (or dry compressed air) and a soft brush to remove dust collected on the external surface/vents.
4. Clean all transparent surfaces with a mild soap solution, ammonia-free glass cleaner, or isopropyl alcohol.
5. Apply the solution directly to a soft, lint free cotton cloth or a lens cleaning tissue.
6. Softly drag any dirt or grime to the outside of the transparent surface.
7. Gently polish the transparent surfaces until they are free of haze and lint.



Always dry the transparent surfaces carefully after cleaning them.

6. Technical Specifications

Dimensions and Weight

Length (w/ Rack Ears)	Length (w/o Rack Ears)	Width	Height	Weight
19.01 in (483 mm)	10.55 in (268 mm)	3.30 in (84 mm)	10.35 in (263 mm)	12 lb (5.4 kg)

Note: Dimensions in inches are rounded.

Power

Power Supply Type	Range	Voltage Selection
Switching (internal)	100 to 240 VAC, 50/60 Hz	Auto-ranging

Parameter	120 V, 60 Hz	208 V, 60 Hz	230 V, 50 Hz
Consumption	530 W	560 W	558 W
Operating Current	4.68 A	2.69 A	2.5 A

Power I/O	U.S./Worldwide	UK/Europe
Power Connectors	Seetronic Powerkon IP65	Seetronic Powerkon IP65
Power Cable plug	Edison (U.S.)	Local plug

ÉPIX Product Output

Output Connector	Output Voltage	ÉPIX Product	Maximum Load per port	LEDs per product
4-pin XLR x2	48 VDC	ÉPIX Strip IP	10 products	100
		ÉPIX Strip IP 50	20 products	50
		ÉPIX Strip Tour	18 products	50
		ÉPIX Strip Tour 50	36 products	25
		ÉPIX Bar Tour	6 products	150
Any combination up to 1000 IP LEDs or 900 Tour LEDs per port				

Maximum Cable Lengths

Parameter	Shielded	Unshielded
From Drive to 1st product	65 ft (20 m)	200 ft (60 m)
Between products	60 ft (18 m)	75 ft (23 m)
Total from Drive through all products	210 ft (64 m)	300 ft (91 m)

Art-Net™/sACN

I/O Connector	Channel Range (per ÉPIX Strip IP)	Universes
Seetronic Etherkon IP65	7 (total), 8, 15, 30, 75, 150, 300, or 301	10 per port

ArKaos Kling-Net

I/O Connector	Channel Range
Seetronic Etherkon IP65	Determined per ArKaos MediaMaster software

Thermal

Maximum External Temperature	Cooling System
113 °F (45 °C)	Convection

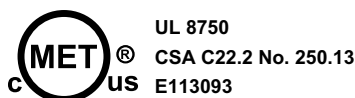

Technical Specifications

Ordering

ÉPIX Products

Product Name	Item Name	Item Code	UPC Number
ÉPIX Drive 2000 IP	EPIXDRIVE2000IP	03081319	781462216672
ÉPIX Strip IP	EPIXSTRIPIIP	03091318	781462216665
ÉPIX Strip IP 50	EPIXSTRIPIIP50	03091435	781462217839
ÉPIX Strip Tour	EPIXSTRIPTOUR	03091139	781462214876
ÉPIX Strip Tour 50	EPIXSTRIPTOUR50	09031436	781462217846
ÉPIX Bar Tour	EPIXBARTOUR	03091140	781462214883

Accessories

Product Name	Item Name	Item Code	UPC Number
ÉPIX Strip Tour Dome Accessory (4 pieces)	EPIXSTRIPDOME	03091142	781462214906

4-pin XLR Cables

Product Name	Item Name	Item Code	UPC Number
4-pin XLR Extension Cable, 16 in	4PINEXT16IN	19111143	781462214913
4-pin XLR Extension Cable, 5 ft	4PINEXT5FT	19111144	781462214920
4-pin XLR Extension Cable, 50 ft	4PINEXT50FT	19111147	781462214951

etherCON Cables

Product Name	Item Name	Item Code	UPC Number
Neutrik® etherCON® Extension Cable, 18 in	ETHERCONEXT18IN	19090363	781462207151
Neutrik® etherCON® Extension Cable, 5 ft	ETHERCONEXT5FT	19090364	781462207168
Neutrik® etherCON® Extension Cable, 10 ft	ETHERCONEXT10FT	19090365	781462207175
Neutrik® etherCON® Extension Cable, 25 ft	ETHERCONEXT25FT	19090366	781462207182
Neutrik® etherCON® Extension Cable, 50 ft	ETHERCONEXT50FT	19090367	781462207199

powerCON Cables

Product Name	Item Name	Item Code	UPC Number
Neutrik® powerCON® Extension Cable, 18 in	POWERCONEXT18IN	19110372	781462207243
Neutrik® powerCON® Extension Cable, 5 ft	POWERCONEXT5FT	19110373	781462207250
Neutrik® powerCON® Extension Cable, 10 ft	POWERCONEXT10FT	19110374	781462207267
Neutrik® powerCON® Extension Cable, 25 ft	POWERCONEXT25FT	19110375	781462207274
Neutrik® powerCON® Extension Cable, 50 ft	POWERCONEXT50FT	19110376	781462207281

For the most current list of related products and accessories available from Chauvet Professional, visit our website at www.chauvetprofessional.com.

Contact Us

General Information	Technical Support
Chauvet World Headquarters	
Address: 3360 Davie Rd. Davie, FL 33314 Voice: (954) 577-4455 Fax: (954) 929-5560 Toll Free: (800) 762-1084	Voice: (844) 393-7575 Fax: (954) 756-8015 Email: chauvetcs@chauvetlighting.com Website: www.chauvetprofessional.com
Chauvet U.K.	
Address: Pod 1 EVO Park Little Oak Drive, Sherwood Park Nottinghamshire, NG15 0EB UK Voice: +44 (0) 1773 511115 Fax: +44 (0) 1773 511110	Email: UKtech@chauvetlighting.eu Website: www.chauvetprofessional.eu
Chauvet Benelux	
Address: Stokstraat 18 9770 Kruishoutem Belgium Voice: +32 9 388 93 97	Email: BNLtech@chauvetlighting.eu Website: www.chauvetprofessional.eu
Chauvet France	
Address: 3, Rue Ampère 91380 Chilly-Mazarin France Voice: +33 1 78 85 33 59	Email: FRtech@chauvetlighting.fr Website: www.chauvetprofessional.eu
Chauvet Germany	
Address: Bruno-Bürgel-Str. 11 28759 Bremen Germany Voice: +49 421 62 60 20	Email: DEtech@chauvetlighting.de Website: www.chauvetprofessional.eu
Chauvet Mexico	
Address: Av. de las Partidas 34 - 3B (Entrance by Calle 2) Zona Industrial Lerma Lerma, Edo. de México, CP 52000 Voice: +52 (728) 690-2010	Email: servicio@chauvet.com.mx Website: www.chauvetprofessional.mx

Warranty & Returns

For warranty terms and conditions and return information, please visit our website.

For customers in the United States and Mexico: www.chauvetlighting.com/warranty-registration.

For customers in the United Kingdom, Republic of Ireland, Belgium, the Netherlands, Luxembourg, France, and Germany: www.chauvetlighting.eu/warranty-registration.