

VLX Series

VLX-TC1-CF • VLX-TCW2H-C • VLX-TCW2V-C

1GbE Visual Lossless Low Latency AV over IP



VLX-TC1-CF



VLX-TCW2V-C



VLX-TCW2H-C



SAFETY INSTRUCTIONS

Please review the following safety precautions. If this is the first time using this model, then read this manual before installing or using the product. If the product is not functioning properly, please contact your local dealer or Aurora for further instructions.



The lightning symbol in the triangle is used to alert you to the presence of dangerous voltage inside the product that may be sufficient to constitute a risk of electric shock to anyone opening the case. It is also used to indicate improper installation or handling of the product that could damage the electrical system in the product or in other equipment attached to the product.



The exclamation point in the triangle is used to alert you to important operating and maintenance instructions. Failure to follow these instructions could result in injury to you or damage to the product.



Be careful with electricity:

- **Power Outlet:** To prevent electric shock, be sure the electrical plug used on the product power cord matches the electrical outlet used to supply power to the Aurora product. Use the power adapter and power connection cables designed for this unit.
- **Power Cord:** Be sure the power cord is routed so that it will not be stepped on or pinched by heavy items.
- **Lightning:** For protection from lightning or when the product is left unattended for a long period, disconnect it from the power source.



Also follow these precautions:

- **Ventilation:** Do not block ventilation slots, if applicable, on the product, or place any heavy object on top of it. Blocking airflow could cause damage. Arrange components so that air can flow freely. Ensure that there is adequate ventilation if the product is placed in a stand or cabinet. Put the product in a properly ventilated area, away from direct sunlight or any source of heat.
- **Overheating:** Avoid stacking the Aurora product on top of a hot component, such as a power amplifier.
- **Risk of Fire:** Do not place unit on top of any easily combustible material, such as carpet or fabric.
- **Proper Connections:** Be sure all cables and equipment are connected to the unit as described in this manual.
- **Object Entry:** To avoid electric shock, never stick anything in the slots on the case, or remove the cover.
- **Water Exposure:** To reduce the risk of fire or electric shock, do not expose to rain or moisture.
- **Cleaning:** Do not use liquid or aerosol cleaners to clean this unit. Always unplug the power to the device before cleaning.
- **ESD:** Handle this unit with proper ESD care. Failure to do so can result in failure.

FCC

This device complies with Part 15 of the FCC Rules. Operation is subject to the following two (2) conditions:

1. This device may not cause harmful interference.
2. This device must accept any interference received, including interference that may cause undesired operation.



Trademarks

All trademarks in this document are the properties of their respective owners.

TABLE OF CONTENTS

PACKAGE CONTENTS	4
OPTIONAL ACCESSORIES	5
INTRODUCTION	9
About	9
Documentation	9
Features	10
VLX-TC1-CF Front.....	11
VLX-TC1-CF Rear.....	13
VLX-TCW2H-C Front	14
VLX-TCW2V-C Front	16
VLX-TCW2H-C and VLX-TCW2V-C Rear	18
VLX-TC1-CF Dante® Option Slot	19
VLX-TCW2 Wall Plate Additional Button and LED Functions.....	20
UNDERSTANDING THE BASICS	21
Direct Connection with No Ethernet Switch	21
10GbE Ethernet Switch	21
Network Infrastructure.....	21
Isolated Network or Users Network	21
Controlling the VLX	21
Controlling the VLX for Redundancy.....	22
EDID and its Importance	22
Video Wall Capabilities	22
Ethernet Bandwidth Usage	22
HARDWARE INSTALLATION	24
Network Setup.....	24
Encoder Setup.....	24
Decoder Setup	24
Control Setup	24
Dante® Option Card Setup	25
WEB SETUP PAGES	26
Encoder Mode Web Pages	26
Decoder Mode Web Pages.....	36
APPLICATIONS	48
Example 1: VLX-TCW2 Configured as Transmitter to VLX-TC1 Configured Receiver	48

Example 2: VLX Multi-Room	49
Example 3: Matrix – Multiple VLX to Multiple VLX.....	50
Example 4: Video Wall	51
Example 5: KVM Utilizing USB 2.0	52
Example 6: VLX-TC1-CF with Local Ethernet Control	53
Example 7: VLX-TC1-CF Daisy Chain	55
Example 8: VLX-TC1-CF Independent Dante®/AES67 Switch	56
SOFTWARE.....	57
IPBaseT Manager PC Control Tool	57
CONNECTOR PIN DEFINITION.....	59
HDMI	59
CAT5e/6/6A.....	60
RS-232	61
IR (Infrared).....	62
APPENDIX 1.....	63
Troubleshooting	63
APPENDIX 2.....	65
Firmware Update.....	65
APPENDIX 3.....	66
Protocol	66
APPENDIX 4.....	67
Recommended Cabling.....	67
APPENDIX 5.....	68
Recommended Network Switches	68
APPENDIX 6.....	70
Technical Specifications.....	70
APPENDIX 7.....	72
Warranty.....	72

PACKAGE CONTENTS

Please make sure the following items are included within your package. Contact your dealer if any items are missing or damaged.

Box Versions

VLX-TC1-CF

- 1 QTY VLX-TC1-CF 1G RJ-45/SFP Copper Transceiver Unit
- 2 QTY Mounting Ears and screws

Wall Plate 2 Gang Versions

VLX-TCW2V-C

- 1 QTY VLX-TCW2V-C 1G RJ-45 Copper Transceiver Unit with VGA and HDMI Inputs

VLX-TCW2H-C

- 1 QTY VLX-TCW2H-C 1G RJ-45 Copper Transceiver Unit with 2 HDMI Inputs

Power supplies are sold separately.

***Note:** Go to www.auroramm.com for latest manual and firmware.

OPTIONAL ACCESSORIES

- **RK2-1-K**
(1RU Rack Mount Holds 2 Units)
Includes 4 rails and 1 blank



- **RK2-5-K**
(5RU Rack Mount Holds 12 Units)
Includes 24 rails and 4 blanks

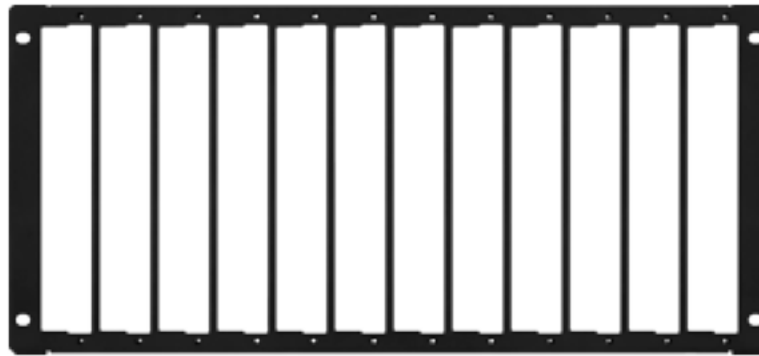

- **RK2-BP-K**
(Blank Plate for Rack Mounts)
RK2-RL-K
(For VLX-TC1 Use in Rack Mounts)



- **IPE-DTE-1**
(Dante® Option Card)



- **IPX-ReAX-1**
(IPX-TC3 ReAX Control System Option Card)



- **VLX-LCVR**
(VLX Wall Plate LAN Port Cover)



- **IPX-SFP-RJ45-1**
(1G RJ-45 LAN SFP Module)



- **IPX-SFP-1GMM-1**
(1G Multi-Mode Fiber SFP Module)



- **IPX-SFP-1G20**
(1G Single-Mode Duplex Fiber SFP Module)



- **DXB-8**
(8 Button Wall Plate)



- **PS0081-1**
(48V 24 Watt PoE Injector)
Available in -US, -AU, -EU, and -UK worldwide models



- **PS0094-3**
(48V 25 Watt Wall Supply)
Comes with US, AU, EU, and UK interchangeable blades



- **IR Receiver CA0026-1**



- **IR Emitter CA0061-1**



- IR Blaster CA0049-1

- **RS-232 Adaptor CA0052-F2T3R**
(3.5mm TRS to FEMALE DB89 2-TX 3-RX)
- **RS-232 Adaptor CA0052-F3T2R**
(3.5mm TRS to FEMALE DB89 3-TX 2-RX)
- **RS-232 Adaptor CA0052-M2T3R**
(3.5mm TRS to MALE DB9 2-TX 3-RX)
- **RS-232 Adaptor CA0052-M3T2R**
(3.5mm TRS to MALE DB9 3-TX 2-RX)



- LVR-2G Gang Electrical Ring



INTRODUCTION

About

The VLX Series provides one of the most advanced IP Streaming solutions on the market utilizing Aurora's IPBaseT[®] technology, which synergizes various IP/AV standards to work together as one. It is the industry's first 4K UHD transceiver with only 1.5 Frame (25ms) latency and visually losses compression. Using a transmitter (encoder) and receiver (decoder), respectively, used to be the standard – until now. The VLX Series box or wall plates can be set up as either one to make installation, inventory, and troubleshooting easier.

Another industry first is the option slot to add other IP capabilities, like Dante[®] audio, for a more complete, distributed system. Audio, video, data, and control can be sent securely to one or many units using off-the-shelf 1G RJ-45 Ethernet switch. When the VLX is set up to be a transmitter, the 2 HDMI inputs (VLX-TC1-CF, VLX-TCW2H-C) or VGA/HDMI inputs (VLX-TCW2V-2) become a source switch and the HDMI output becomes a potential loop out. When set up as a receiver, a user can select the local HDMI inputs or an IP source. Fast-switching of the sources further enhances the presentation (Matching source resolutions and frame-rate required). Regardless of how the VLX is set up, the audio can be de-embedded at any location, and/or be sent to or received from a Dante[®] enabled device. The USB is also flexible, working as a KVM and/or a high-speed data transfer (50Mbps) for memory sticks. Each VLX USB feature can also be set as a host or a device. To keep the system friendly, an OSD and integrated web server are available for easy navigation and setup of features.

Digital signage, education, corporate, and residential are just a few markets which benefit from the flexibility and low cost of the VLX Series.

Documentation

Aurora provides many documents to support the VLX series and accessories. Below is a list of the available documents that can be found on the download tab of the VLX products or the customer portal.

- VLX Series Network Switch Recommendation and Configuration
- VLX Series Protocol Guide (Available only on Customer Portal)
- IPBaseT[®] FAQ (Frequently Asked Questions)
- IPBaseT[®] VLX Series AV Evolution for an Industry Revolution (Features and the benefits over tradition Matrix)
- IPBaseT[®] Brochure
- IPBaseT[®] for Better Education

Features

- ◆ Configure as Transmitter (Encoder) or Receiver (Decoder)
- ◆ 4K60 4:2:0/4K30 4:4:4 Over 1G CAT5e/6/6a
- ◆ HDMI 2.0, HDCP 2.2
- ◆ Visually Lossless with only 1.5 Frame Latency
- ◆ 1080P to 4K and 4K to 1080P Scaling
- ◆ 128 per source with HDCP, Larger for Non-Encrypted Sources
- ◆ Video Wall with Image Rotation
- ◆ 1G LAN PoE
- ◆ 2 HDMI Inputs, 1 HDMI Output (VLX-TC1-CF, VLX-TCW2H-C)
- ◆ 1 VGA/1 HDMI Inputs, 1 HDMI Output (VLX-TCW2V-C)
- ◆ Line In/Out Stereo
- ◆ RS-232 Serial Port & IR (In/Out)
- ◆ On Screen Display (OSD)
- ◆ Integrated Web Server for Configuration and Control
- ◆ USB 2.0 Host and Device ports
- ◆ 2 USB 1.1 for HID devices (VLX-TC1-CF)
- ◆ Dante® IP Audio Option
- ◆ Front Keypad and IR Remote with lockout function
- ◆ Auto Sense Switching
- ◆ Rack and Under Table Mounting (VLX-TC1-CF)
- ◆ 2 Gang Mounting for Wall plates (VLX-TCW2V-C, VLX-TCW2H-C)
- ◆ Available in White or Black (VLX-TCW2V-C, VLX-TCW2H-C)



***Note: Wall plate versions require full 2 gang electrical box space. Some electrical boxes and mud rings do not accommodate the full size. Read specifications for dimensions.**

VLX-TC1-CF Front



LEDs

- **Power/Status:** Power will light green when unit is on or in standby. Status will blink at a normal pace during regular operation and slower pace when in standby.
- **Encoder/Decoder:** Encoder (transmit) or Decoder (receiver) will be lit when set accordingly.
- **HDMI 1/HDMI 2:** Will light accordingly based on input selection. If both are lit, then it is the remote stream when set as a decoder. If neither is lit, then no source is routed.
- **232 TX/RX:** Will blink when RS-232 data is being sent or received.
- **IR TX/RX:** Will blink when IR signal is being sent or received.
- **Host/Device:** For USB option. Host will be lit if set for PC to be connected to the USB. Device will be lit if set for peripherals like keyboard or mouse is to be connected.
- **LAN Connector LED's (Rear):**
 - Left LED Green = 1G/Good
 - Left LED Orange = 10/100 or Bad Connection
 - Right LED is Orange, for general LAN Activity

Buttons

- **Power Button:** Press and hold for 5 seconds for power standby.
- **Menu Button:** Press and hold for 5 seconds switch between encode and decode mode.
- **Up Button:** Select next input source.
- **Down Button:** Select previous input.
- **Enter Button:** Pressing will toggle Link On/Off. This stops streamed Video, IRoIP, SoIP and USBoIP. If the VLX device is connected in the network the status led will go on/off to indicate that link has gone on/off.

Miscellaneous

- **IR Window:** IR remote and IR pass through.
- **IR Input:** For use with external IR Receiver. If utilized, front IR window will become disabled.

***Note: It is important to use 5V only photo receiver which is with carrier and inverted. Use a stereo 3.5mm TRS connector.**

- **USB HID:** Dual Type A USB 1.1 Connectors for keyboard/mouse.

Special Functions

- **Factory Default:** Press Power and Menu for 5 seconds. The USB Host LED will blink to indicate factory default and the unit will reboot.
- **Reboot:** Press Power button for 5 seconds. Power LED goes off and the board reboots.
- **Secondary Firmware Image Mode:** Press Power and Down button while powering up for 5 seconds. The Host and Device LEDs will keep blinking and both Encoder and Decoder LEDs will be on.
- **IP Information on RS-232:** Press and hold UP and DOWN for 5 seconds and the units IP information will reveal on RS-232 port at 9600 baud 8N1.

Default Settings

- **Baud Rate:** 9600
- **IP Mode:** DHCP
- **Fallback IP Mode (no DHCP Present):** Auto-IP 169.254.xxx.xxx range
- **Autosense:** Off

VLX-TC1-CF Rear



Rear

From left to right:

- **48VDC:** 48 Volt isolated power input; 10/100/1000Mbps LAN; can power the unit with PoE from injector or switch.
- **LAN Connector LED's (Rear):**
 - Left LED Green = 1G/Good (1G is required for proper operation)
 - Left LED Orange = 10/100 or Bad Connection
 - Right LED is Orange, for general LAN Activity
- **USB 2.0:** 50Mbps USB 2.0 Micro to be connected to a host (PC) or device (i.e., mouse, keyboard, etc.)
- **Control IR Out:** Infrared control output 30kHz-60kHz. IR emitter must be mono 3.5mm TS.
- **HDMI in 1/ In 2:** HDMI inputs up to 4K30p/4:4:4 or 4K60p/4:2:0.
- **HDMI Out:** HDMI Output to Display up to 4K30p/4:4:4 or 4K60p/4:2:0. Output can be native or scaled (e.g. from 1080p to 4K30p/4:4:4).
- **Audio In:** Analog stereo audio input.
- **Audio Out:** Analog stereo audio output. De-embedded audio output from HDMI stream. HDMI multichannel audio (up to 7.1) is down mixed to stereo (2 channel).
- **Control RS-232:** Serial port pass-through and control up to 115Kbps.
- **SFP:** SFP Cage for Multi-mode or Single Mode Fiber and RJ-45 LAN with optional modules available from Aurora.

VLX-TCW2H-C Front



Buttons

- **In 1:** Selects HDMI Input 1 (Lights Red, Green, or Blue).
- **In 2:** Selects HDMI Input 2 (Lights Red, Green, or Blue).
- **Stream:** Selects remote stream assigned when set as decoder (Lights Red, Green, or Blue). If held for 5 seconds will switch between encode and decode modes. Stream button will light blue when in encode mode.

Connectors

- **HDMI In 1/2:** HDMI inputs up to 4K30 4:4:4/4K60 4:2:0.
- **HDMI Out:** HDMI Output to Display.
- **RS-232:** Serial port pass-through and control up to 115Kbps.
- **IR Output:** For InfraRed output of 30kHz-60kHz. Uses 3.5mm TS emitter.
- **Audio In:** Stereo audio input.
- **Audio Out:** Audio de-embedded output.
- **Ethernet:** 10/100 LAN.
- **USB:** USB 2.0 Type A to be connected to a host (PC) or device (i.e., Mouse, keyboard, etc.).

Miscellaneous

- **IR Window:** IR remote or IR pass-through.

Special Functions

- **Factory Default:** Press [IN2] and [STREAM] button till white LED turns on for a second. Release the switches once the white led turns on, on both the buttons. The unit will reboot automatically after factory default.
- **Reboot:** Press [In1] button for 5 seconds. All lit LEDs will be off now and the board reboots.
- **Secondary Firmware Image Mode:** Press [In1] and [In2] button while powering up for 5 seconds. The LED in buttons In1 and In2 will light Red once the board has finished booting to indicate secondary mode. This may be necessary if for some reason the firmware becomes corrupted during a firmware update.

LED Indications

- When power is first applied, all front LEDs will light white for a second.
- All LEDs will light white to indicate that the firmware update is in progress.
- Selected input source LED will light red.
- Encoder mode is indicated by a blue led on stream button.
- Both In1 and In2 LEDs will light Red to indicate secondary mode.

Default Settings

- **Baud Rate:** 9600
- **IP Mode:** DHCP
- **Fallback IP Mode (no DHCP Present):** Auto-IP 169.254.xxx.xxx range
- **Autosense:** Off

VLX-TCW2V-C Front



Buttons

- **In 1:** Selects VGA (Lights Red, Green, or Blue).
- **In 2:** Selects HDMI Input 2 (Lights Red, Green, or Blue).
- **Stream:** Selects remote stream assigned when set as decoder (Lights Red, Green, or Blue). If held for 5 sec will switch between encode and decode modes. Stream button will light blue when in encode mode.

Connectors

- **VGA In:** VGA input up to 1900 x 1200 @ 60Hz.
- **HDMI In:** HDMI inputs up to 4K30/4:4:4 or 4K60/4:2:0.
- **HDMI Out:** HDMI Output to Display.
- **RS-232:** Serial port pass-through and control up to 115Kbps.
- **IR Output:** For InfraRed output of 30kHz-60kHz. Uses 3.5mm TS emitter.
- **Audio In:** Stereo audio input.
- **Audio Out:** Audio de-embedded output.
- **Ethernet:** 10/100 LAN.
- **USB:** USB 2.0 Type A to be connected to a host (PC) or device (ex. Mouse, keyboard, etc.).

Miscellaneous

- **IR Window:** IR remote or IR pass-through.

Special Functions

- **Factory Default:** Press In1 and In2 button till white LED turns on for a second. Release the switches once the white led turns on, on both the buttons. The unit will reboot automatically after factory default.
- **Reboot:** Press In1 button for 5 seconds. All lit LEDs will be off now and the board reboots.
- **Secondary Firmware Image Mode:** Press In1 and In2 button while powering up for 5 seconds. The LED in buttons In1 and In2 will light Red once the board has finished booting to indicate secondary mode. This may be necessary if for some reason the firmware becomes corrupted during a firmware update.

VGA Port Resolutions

- 800x600, 1024x768, 1280x720, 1280x768, 1280x800, 1280x960, 1280x1024, 1360x768
- 1440x900, 1600x1200, 1680x1050, 1920x1080

Default Settings

- **Baud Rate:** 9600
- **IP Mode:** DHCP
- **Fallback IP Mode (no DHCP Present):** Auto-IP 169.254.xxx.xxx range
- **Autosense:** Off

VLX-TCW2H-C and VLX-TCW2V-C Rear

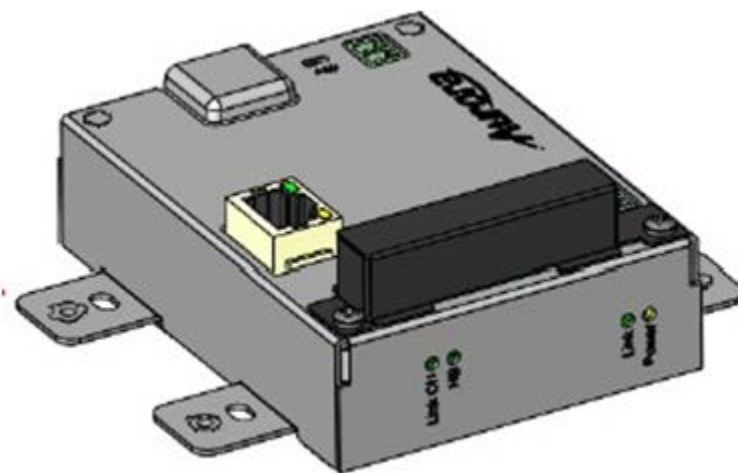

Rear

- **48VDC:** 48 Volt DC isolated power input
- **LAN:** 10/100/1000Mbps LAN. Can power the unit with PoE from injector or switch.
- **RS-232:** Serial port pass-through and control up to 115Kbps. Also, has 5V for connection to DXB-8 8 button wall controller.
- **Expansion Slot for Dante® Option:** Cover supplied for card protection.

***Note: Wall plate versions require full 2 gang electrical box space. Some electrical boxes and mud rings do not accommodate the full size. VLX-TCW2 wall box dimensions are 3.728" x 2.83" x 1.404". Wall box portion depth is 1.404" without option card and 2.25" with option card.**

VLX-TC1-CF Dante® Option Slot

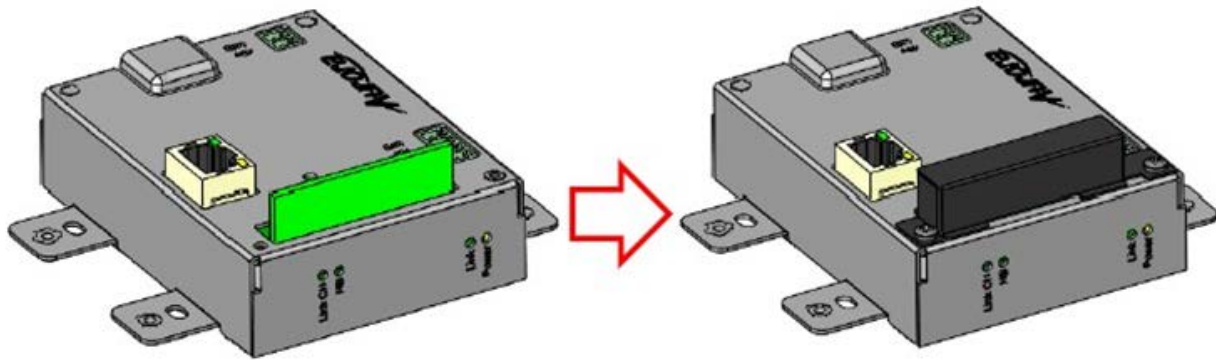

- Option card slot for Dante® option.

****Note: The MAC address for the Dante® option will be on the card label.***

VLX-TCW2 Wall Plate Additional Button and LED Functions

LED Indications

- **Encoder/Decoder Indication:** Blue LED to be lit on Stream button in Encoder Mode.
- **Source Indication:** Red LED to be lit on the button corresponding to the source.

Button Functionalities

- **Secondary Boot:** Press and hold the IN2 button while booting.
- **Factory Default:** Press and hold the IN2 and Stream button for 5 seconds.
- **Encoder Decoder Selection:** Press and Hold Stream button for 5 seconds.
- **Reboot:** Press and Hold IN1 button for 5 seconds.

UNDERSTANDING THE BASICS

Direct Connection with No Ethernet Switch

The VLX Series is designed to automatically tunnel the video, audio, USB, RS-232, and IR if they are connected without an Ethernet switch once they have been connected for the first time with an Ethernet switch.

10GbE Ethernet Switch

It is important to use a non-blocking IGMP 1GbE switch with IGMP snooping and Jumbo packets. The size of the switch is based on the requirements of the project. With this in mind, consider if extra port capacity is required for future expansion. If you run out of port capacity, you can always add another 1GbE switch in the future. The VLX, when set to encoder (TX), determines the bandwidth that will be multicast across the network. 24bit 4k@30Hz can peak at about 850Mbps and 425Mbps for 24bit 1080p@60Hz (Data Rate in bits per second = Color Depth x Horizontal Resolution x Vertical Resolution x Frame Rate) but typically averages 218Mbps for full motion 4K video. This does not include the 10/100 LAN, 50Mbps USB, RS-232, IR over the same transmission if required. If 10 units are set as encoders, and 4K@30Hz is the desired video resolution, then 8.5Gbps of bandwidth will be required if uplinked to another switch. If the available bandwidth between the two 1GbE switches is less than 8.5Gbps, then packets will drop and information will be lost. It is also a good idea to take into account overhead and assume 15% bandwidth loss to play it safe. Since each port is bi-directional 1Gbps, it enables any port to be used as an encoder or decoder. The AV industry is used to standard distribution topology limitations of 4x4, 8x8, 16x16, etc. With networked based video distribution, a 48 port 1GbE switch as an example can be 24x24, 1x47, 47x1, 12x36, etc. If bandwidth is tight the VLX has the ability to cap the bandwidth at 200Mbps which will work well for most applications. (see [Ethernet Bandwidth Usage](#) section for more detailed information).

Network Infrastructure

The raw network cabling as well as the patch cables are as important as the switch. When using copper, CAT5e, 6, or 6a cable is preferred for optimal performance and is important to follow the standard rules for running Ethernet cables. No sharp bends, coiling, putting near power lines, grouping unshielded cables tightly together with other LAN cables, etc. Shielding is not necessary but can be used for noisy environments.

Isolated Network or Users Network

When discussing a networked based video solution, many times it is assumed it has to be on the client's network. This is not true. The application determines the type of network to be used. For example, if it is simply being used as a typical AV matrix switch with no distribution throughout the facility, then a 1GbE switch can be used just for that room. Just because it is Ethernet based does not mean it has to be used on the main network. The Ethernet switch is simply used as the end point for all the cables and the glue that holds everything together. In other words, it takes the place of the standard AV matrix switch topology. If only remote control is required from the main network, then connect the 1GbE switch to the main network and allow the control data between the 1GbE switch VLAN and the main network. Even if the VLAN is part of the main network it does not mean you will use all the bandwidth. The purpose of IGMP, is to only send the multicast data to the ports specified, which would be where the VLX units are connected to. Non-blocking switch assures full bandwidth is available for all ports as required.

Controlling the VLX

To simplify control of the VLX, each unit can be controlled via the Aurora IPBaseT Manager server, either running on a PC or on a dedicated control appliance (RXS-1). It can also be controlled from other Aurora control products or third party control systems with the available VLX API. In order to obtain the VLX Server API commands you must be dealer status otherwise an NDA is required and is at the discretion of Aurora. The VLX can also work without the server as a third party control can communicate directly to each unit to change settings or make routes. This makes the VLX extremely flexible and for low cost smaller systems very cost effective.

Controlling the VLX for Redundancy

Multiple control systems can run on the same network for redundancy. It is important only one communicates at any given time or incomplete commands may occur between units communicating simultaneously.

EDID and its Importance

One of the most forgotten setup procedures in AV systems is the EDID. The EDID comes from the destination (display, VTC, recorder, etc.) and must be saved into the encoder and decoder HDMI input ports. This allows the source (Blu-ray, computers, etc.) to know the capabilities of the destination. This includes the audio type if any, video resolution and timing, color space, color depth, and more. If no EDID is present an HDMI device will revert to lowest resolution in DVI mode which also means no audio. If the wrong EDID is used, the image may look pink, green, or have no image at all. To make matters more complex, if different destinations/displays are in use in a matrix configuration, then it is important to use an EDID with a common denominator or only one or the other destination may work. In an ideal installation, all the destinations should have the same capabilities for optimal performance. If this is not possible a scaler may have to be implemented to assist in the compatibility.

For example, there are 2 displays one 1080p the other 4k UHD. If the EDID of the 4K display is used, the 1080p will not see an image if the source is capable of 4K. If the 1080p EDID is used, then both will see the image but the 4K will never benefit from 4K content. In a situation where this is unacceptable, a 4K scaler can be used on the 1080p screen to down scale the 4K content so the 4K EDID can be used and the better screen can have a benefit. Note scalars do add frame latency and can affect image quality based on the quality of the scaler. This is why it is always ideal to use destinations with similar capabilities for optimal performance.

Audio can be impacted just as easily. If a destination is 6-channel surround sound capable and the other destination is not, then the EDID from the 5.1 destination cannot be used, or there will be no audio on the other destination. In most commercial installations, it should not be an issue to choose the lowest common denominator, which is 2-channel audio, but in cases where you must have surround sound then a down-mixer for the 2-channel destination must be used.

In some cases, a custom EDID could be created, as the audio and video are mismatched between the destinations. This can occur for example, when one destination has 4K 2-channel audio and the other 1080p with multichannel surround sound. If the EDID of the 1080p destination is used, audio will not be present on the 4K destination. If the 4K EDID is used, there will be no video present on the 1080p destination. The only way to solve this issue is a new EDID combining the common features. In this case an EDID which is set at 1080p with 2-channel audio is the solution.

Video Wall Capabilities

The VLX video wall mode has the ability to take in up to a 4K UHD signal and create a low latency high quality video wall up to 8x8 in size. The way the mode works is by dividing the input resolution by the amount of displays. For example, a 2x2 video wall will become four 1080p signals from a 4K UHD signal. The VLX also has bezel compensation to create a seamless window pane effect.

Ethernet Bandwidth Usage

The VLX streaming bandwidth is dynamic with the compression a low fixed 8:1 compression. With no USB activity and a still image fed into a decoder the VLX will use as little as 216Kbps of network bandwidth. Maximum throughput is 820Mbps.

USB Network Bandwidth Requirements

- When USB devices are attached but there is no activity, the network bandwidth requirement is almost 0. For non-isochronous USB devices, network performance only impacts the performance of the USB device. It will not impact USB devices' functionality.
- For isochronous USB devices (for example, USB audio), the network latency may impact the functionality of this kind of

device. If the network latency is too long, ISO packets may be discarded and causes audio glitch. It is important to use fast-leave high quality switches for this application.

- For most of USB devices, the network bandwidth requirement will be almost the same as what it takes on USB bus.

Typical Video Network Bandwidth

- **Still Frame:** < 216Kbps
- **Web Browsing:** 70~100Mbps (1920x1080) 60fps
- **YouTube Full Screen:** 21~132Mbps (1920x1080) 60fps
- **Movie Average:** 165~315Mbps (1920x1080) 60fps

Bandwidth Table

Following table is the network bandwidth requirement matrix which measured from playing a video clip. The video clip can be downloaded from http://download.microsoft.com/download/a/d/6/ad6fc147-e95f-4ffd-a2e8-cbd09ca91b00/Amazon_1080.exe (107MB). The average network bandwidth is measured by profiling Ethernet MAC layer traffic. The value in () is the performance variation.

Video Resolution	Quality Level	Maximum Frame Rate	Average Network Bandwidth (Mbps)
3840x2160 (2160p30)	Auto	30	218 (146~268)
1920x1080 (1080p)	Auto	60	133 (80~210)
1280x720 (720p)	Auto	60	147 (112~177)
1600x1200 (UXGA)	Auto	60	81 (57~105)
1280x1024 (SXGA)	Auto	60	113 (79~150)
1024x768 (XGA)	Auto	60	81 (72~120)
800x600 (SVGA)	Auto	60	66 (49~82)
640x480 (VGA)	Auto	60	43 (29~56)

HARDWARE INSTALLATION

Network Setup

1. Connect a 1GbE network switch and make certain IGMP Snooping and Jumbo/MTU Packet features are enabled as per the VLX Series Network Switch Recommendations and Configuration document which can be found on the Aurora website. VLX requires Jumbo/MTU Packet of 8192 or better for full 4K video streaming.
2. Connect CAT cable RJ-45 accordingly to the network switch and to the VLX units.

Encoder Setup

1. Plug HDMI source(s) into the inputs. Local display should be connected to the HDMI output. Connect any other RS-232, IR, USB, or audio accordingly.
2. Connect power via 48v red terminal connector or PoE via LAN connection. Unit will take about 30 seconds to initialize.
3. Make certain the unit's LED is set to Encode. If not, for box version use the front menu button by holding for 5 seconds or the stream button on the wall plate version.
4. For the box version select the input to be streamed using the front up or down buttons to choose HDMI 1 or 2. The HDMI 1/2 LED will light accordingly.
5. Every VLX unit has a unique MAC and IP addresses. It can be changed using through the built-in setup web pages. It is important to make certain each unit has its own unique IP and Host Name.

Decoder Setup

1. Plug the display into the HDMI output. If local sources will also be connected to the decoder, use the HDMI inputs 1 and/or 2. Connect any RS-232, IR, USB, or audio accordingly.
2. Connect power via 48v red terminal connector or PoE via LAN connection. Unit will take about 30 seconds to initialize.
3. Make certain the unit's LED is set to Decode. If not, for box version, use the front menu button by holding for 5 seconds or the stream button on the wall plate version.
4. For the box version select the input to be streamed using the front up or down buttons to choose HDMI 1, 2, or stream. The HDMI 1/2 LED will light accordingly. If both are lit, then stream is selected. For the wall plate use the labeled buttons accordingly.
5. Every VLX unit has a unique MAC and IP addresses. It can be changed using through the built-in web setup pages. It is important to make certain each unit has its own unique IP and Host Name.

Control Setup

1. If the network has a DHCP server, make sure the PC is set to DHCP. If not, make sure the PC is set to a 169.254.xxx.xxx IP address. If the VLX units have previously been set to a static IP address, make sure the PC is set to an IP address in the same subnet.
2. Launch the windows application IPBaseT Manager available on the Aurora customer portal.
3. The units on the network will populate into the encoder and decoder fields accordingly.
4. This will allow you to initially identify and communicate with the built-in web pages to set up each unit or to communicate directly with the VLX protocol.

Dante® Option Card Setup

1. Remove power from the box or wall plate unit.
2. If the Dante® option is not already installed remove the 4 screws from each side of the VLX unit for the box version to remove the top cover or the 2 screws on the rear of the wall plate version to remove the option card cover.
3. Note the MAC address on the IPE-DTE card before installing into the unit to identify which unit the card is associated to. The Dante® option will have its own MAC and IP Address independent of the VLX unit.
4. Insert IPE-DTE card into the edge connector. Note on the box version there is a silk screen outline showing which direction it should be installed. Failure to install in the correct orientation could result in damage to the IPE-DTE card.
5. Reassemble the box or wall plate and power on.

Encoder Mode

Line in audio can be routed either to Dante® or HDMI (to replace HDMI audio). Selection of this can be done from web page or API.

Decoder Mode

Line out audio can be from Dante® or HDMI.

Important:

- **Take note of the MAC Address of every unit. It can be found on the underside or rear of the unit. The MAC Address is how you will identify the unit relative to its location.**
- **Make certain all units are using the latest firmware.**
- **Remember to setup EDID for proper operation.**

WEB SETUP PAGES

Web Setup pages can be accessed by typing in the IP address of the unit followed by /setup (example: 192.168.100.1). You will then be prompted for a password. Default password is admin. Make certain if all the VLX units are already connected to the 1GbE network that each VLX web server has a unique IP Address or there will be communication issues. The images below may change with firmware revisions as we are always enhancing the capabilities.

***Note: All setup and configuration options available in the web setup pages can also be accessed through IPBaseT Manager using a unified, intuitive interface. IPBaseT Manager also allows for mass actions, such as updating firmware to all units at once.**

Encoder Mode Web Pages

The Encoder pages are comprised of 4 tabs, System, Video Wall, Network, and Functions. The video wall tab will do nothing for encoder mode at this time.

System Tab

The System Tab has 4 selections of Version Info, Updating of Firmware, Utilities and Statistics.

Hardware Information

Shows the Units MAC Address, Serial Number and Mode.

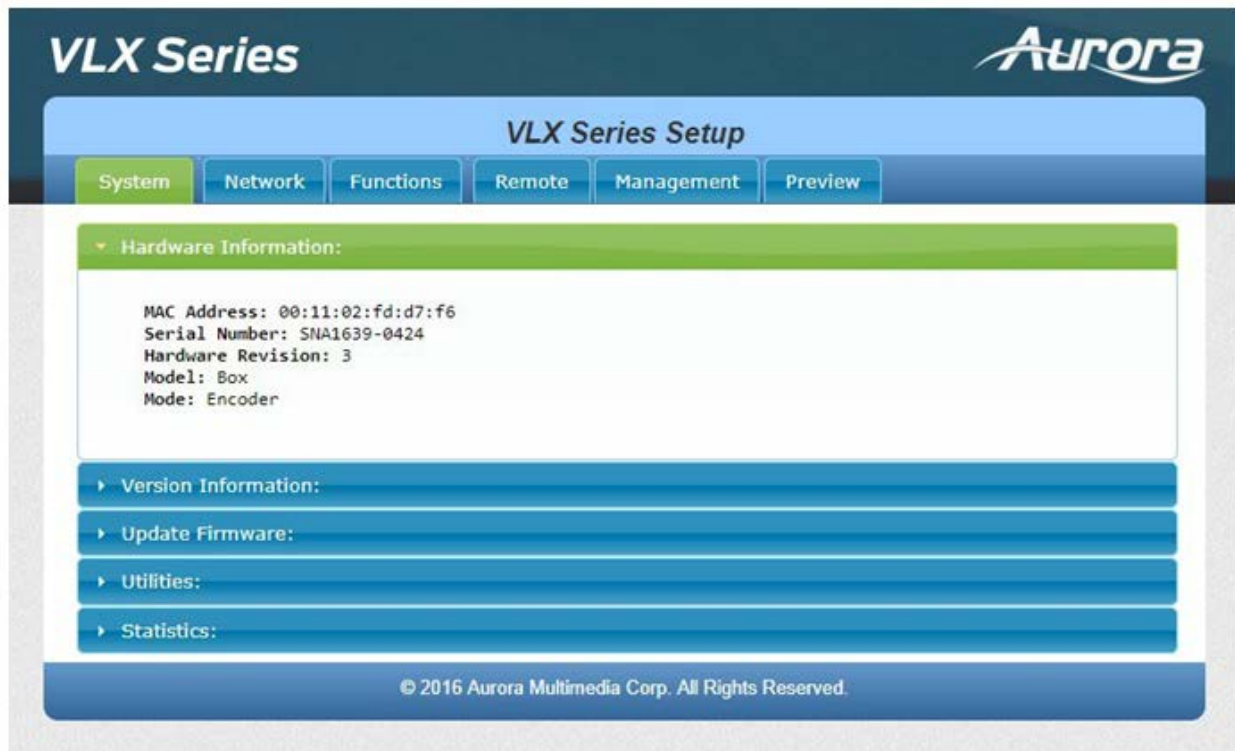

Version

Version reports back the current firmware version. This will help to not only make choices for updating firmware if necessary but by knowing the firmware the user will know the current capabilities that can be expected of the unit.

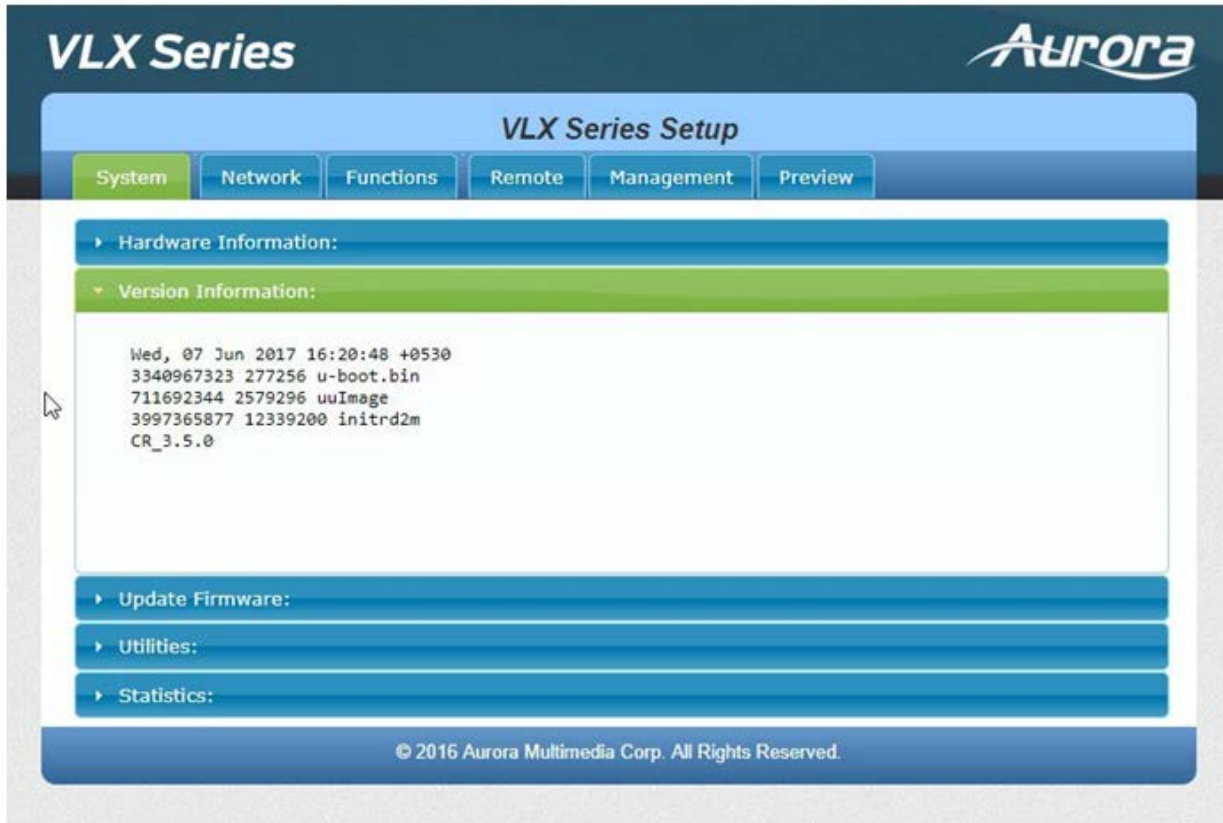

Update Firmware

If updating firmware is necessary, this selection allows a user to select the firmware file and upload to the unit. When the process is done, a notification will appear.

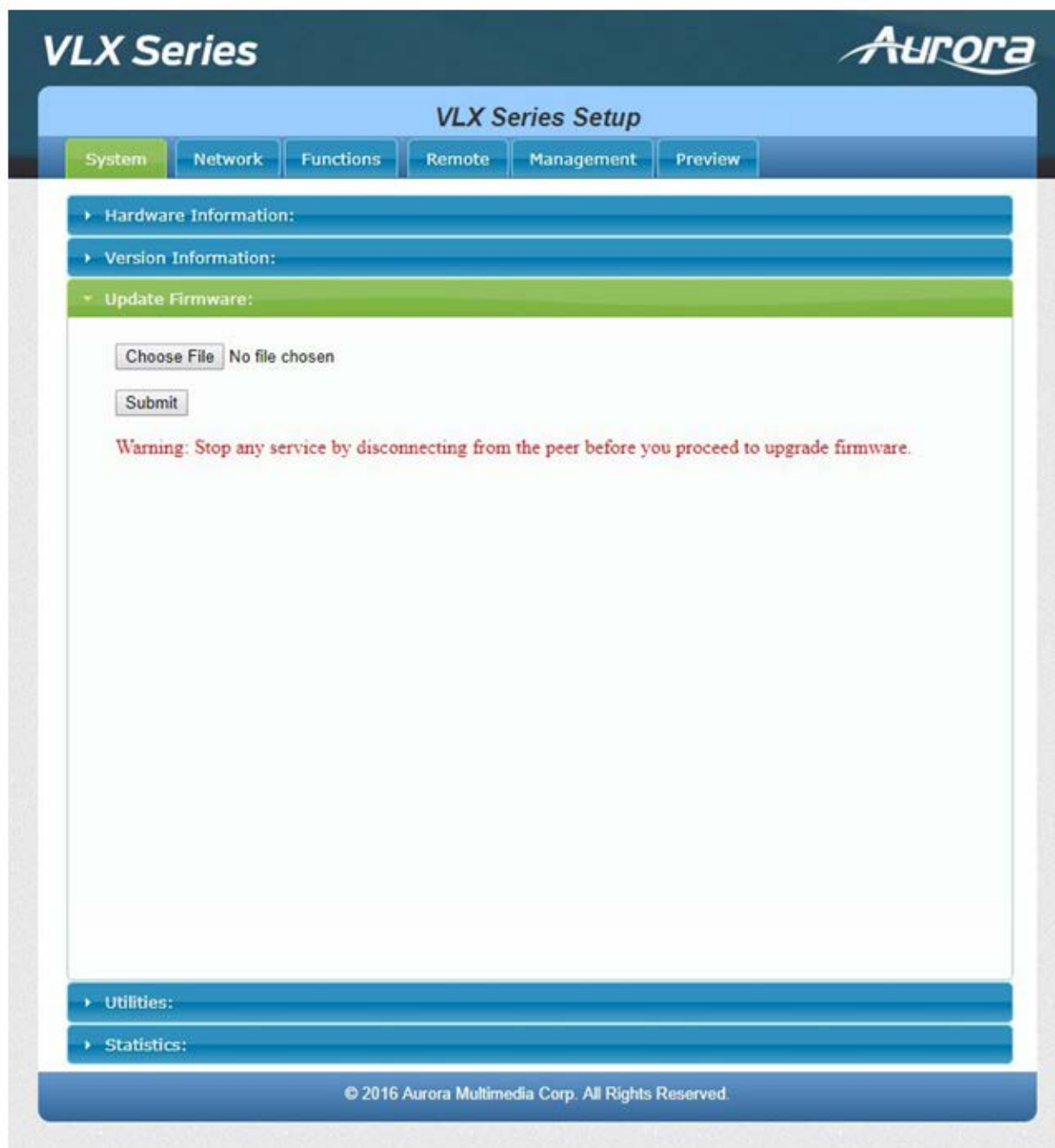

The screenshot displays the 'VLX Series Setup' web interface. At the top, the 'VLX Series' title and the 'Aurora' logo are visible. Below the title bar, a navigation menu includes 'System', 'Network', 'Functions', 'Remote', 'Management', and 'Preview'. The 'System' tab is active, showing a list of expandable sections: 'Hardware Information:', 'Version Information:', 'Update Firmware:', 'Utilities:', and 'Statistics:'. The 'Update Firmware:' section is expanded, revealing a file selection area with a 'Choose File' button and the text 'No file chosen', followed by a 'Submit' button. A red warning message reads: 'Warning: Stop any service by disconnecting from the peer before you proceed to upgrade firmware.' At the bottom of the interface, a footer contains the copyright notice: '© 2016 Aurora Multimedia Corp. All Rights Reserved.'

Utilities

The selection allows factory defaults, remote rebooting, resetting of EDID, as well as the ability to manually enter API commands. The Host ID can also be set up here.

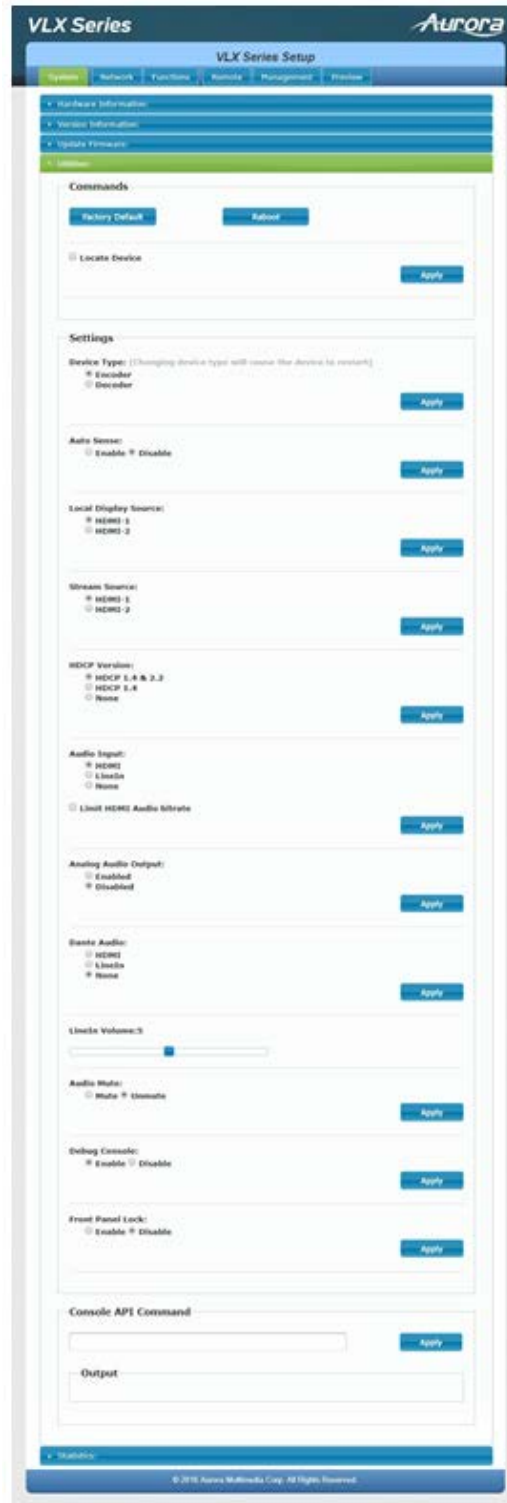

Statistics

This selection is very useful when diagnosing the unit as it reveals important information about the unit itself. Everything from MAC, IP, EDID detail, Video Timing and more is all available to help see the state of the unit.

The screenshot shows the 'VLX Series Setup' web interface. The 'Statistics' section is expanded, displaying the following information:

- State Machine:** State: s_attaching
- Network:**
 - ID (Host Name): 0424
 - IP Address: 192.168.1.150
 - Subnet Mask: 255.255.255.0
 - Default Gateway: 192.168.1.1
 - MAC Address: 001102FDD7F6
 - Casting Mode: Multicast Mode
 - Link Status: on
 - Link Mode: 1G
- Video:**
 - EDID Used:

```

00 ff ff ff | ff ff ff 00 | 04 09 c4 23 | 0b 6b 00 00 |
0c 1a 01 03 | 80 33 1d 78 | 2a e5 95 a6 | 56 52 9d 27 |
10 50 54 bf | ef 00 d1 c0 | b3 00 95 00 | 81 80 81 40 |
81 c0 71 4f | 01 01 02 3a | 80 18 71 38 | 2d 40 38 2c |
45 00 fd 1e | 11 00 00 1e | 00 00 00 ff | 00 47 33 4c |
4d 54 4a 30 | 32 37 34 30 | 33 0a 00 00 | 00 fc 00 41 |
33 35 32 20 | 36 43 32 33 | 39 0a 20 20 | 00 00 00 fd |
00 32 48 18 | 53 11 00 0a | 20 20 20 20 | 20 20 01 93 |
02 03 22 71 | 4f 01 02 03 | 11 12 13 04 | 14 05 0a 0f |
1d 1e 1f 90 | 23 09 17 07 | 83 01 00 00 | 63 03 0c 00 |
ff ff 8c 0a | d0 8a 20 e0 | 2d 10 10 3e | 96 00 04 03 |
00 00 00 18 | 8c 0a d0 8a | 20 e0 2d 10 | 10 3e 96 00 |
10 09 00 00 | 00 18 8c 0a | 00 90 20 40 | 31 20 0c 40 |
55 00 04 03 | 00 00 00 18 | 8c 0a d0 90 | 20 40 31 20 |
0c 40 55 00 | 10 09 00 00 | 00 18 01 1d | 00 bc 52 d0 |
1e 20 b8 28 | 33 40 10 09 | 00 00 00 1e | 00 00 00 41 |

```
 - Local Video Output: attached=n
 - Video Timing Information:

```

Timing Table: Index[13] [1920]x[1080] [60]Hz
Pixel Rate: 148500kHz, htotal: 2200, vtotal: 1125
Hbp: 148, Vbp: 36, HSw: 44, VSw: 5
Progressive, HPos, VPos
color depth: [0]
HDCP: [off]
HDCP convert: disable
capture windows: [1920]x[1080] [60]Hz
compress windows: [1920]x[1080] [60]Hz
active windows: [1920]x[1080] [60]Hz
crt windows: [1920]x[1080]
Scan Mode: Progressive
Signal Type: HDMI 16:9

```

© 2016 Aurora Multimedia Corp. All Rights Reserved.

Network Tab

The Network tab allows the setup of the IP address, Subnet, and Gateway. In addition, the mode of point to point (Unicast) or matrixing (Multicast) can be selected under Casting mode.



VLX Series 

VLX Series Setup

System **Network** Functions Remote Management Preview

IP Setup

IP Mode: Auto IP DHCP Static

IP Address:

Subnet Mask:

Default Gateway:

Host ID

Host Name

© 2016 Aurora Multimedia Corp. All Rights Reserved.

Functions Tab

The Functions tab has selections pertaining to the Video over IP, Maximum bit Rate which is useful for bandwidth restricted networks, and USB over IP settings.

The screenshot displays the 'VLX Series Setup' interface with the 'Functions' tab selected. The interface is divided into two main sections: 'Video over IP' and 'USB over IP'. The 'Video over IP' section includes checkboxes for 'Enable Video over IP' and 'Enable Video Wall', both of which are checked. Below these is a 'Maximum Bit Rate' dropdown menu set to 'Best Effort' and a 'Maximum Frame Rate' slider set to 'Capture up to 100% of frames'. An 'Apply' button is located at the bottom right of this section. The 'USB over IP' section includes a checked 'Enable USB over IP' checkbox and a 'Compatibility Mode' section with two options: 'Mouse not responding well' (unchecked) and 'K/M over IP' (checked). An 'Apply' button is also present at the bottom right of this section. The footer of the interface contains the copyright notice: '© 2016 Aurora Multimedia Corp. All Rights Reserved.'

Remote Tab

The Remote tab has options pertaining to RS-232 control.

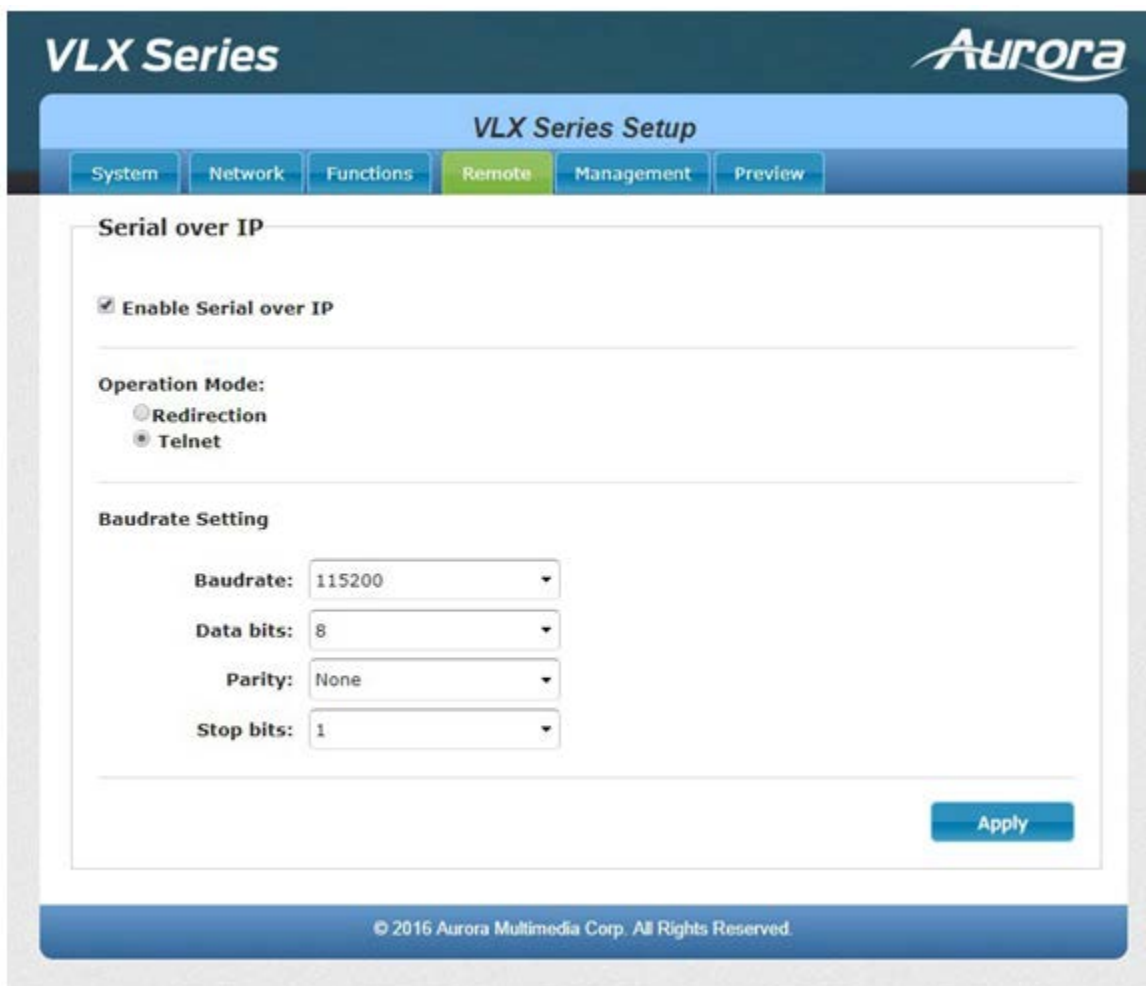

The screenshot shows the 'VLX Series Setup' interface with the 'Remote' tab selected. The page is titled 'VLX Series' and 'Aurora' in the top right corner. The navigation tabs are 'System', 'Network', 'Functions', 'Remote', 'Management', and 'Preview'. The 'Remote' tab is active and displays the following settings:

- Serial over IP**
 - Enable Serial over IP
- Operation Mode:**
 - Redirection
 - Telnet
- Baudrate Setting**
 - Baudrate:** 115200
 - Data bits:** 8
 - Parity:** None
 - Stop bits:** 1

An 'Apply' button is located at the bottom right of the configuration area. The footer contains the copyright notice: © 2016 Aurora Multimedia Corp. All Rights Reserved.

Management Tab

The Management tab manages routing of streaming video sources and mode selection and configuration of serial over IP settings.

The screenshot shows the 'VLX Series Setup' interface for a device identified as 'vlx-series-enc-0312'. The 'Management' tab is selected, and the interface is divided into three main sections: Update Settings, Backup Settings, and Authentication Settings.

Update Settings

Settings Type: Recovery ▾

Config File Name: Choose File No file chosen

Upload

Backup Settings

Download

Authentication Settings

Enable Disable Apply

New User Name:

New User Password:

Confirm Password:

Apply

© 2016 Aurora Multimedia Corp. All Rights Reserved.

Preview Tab

The Preview tab allows you to look at the active video source.

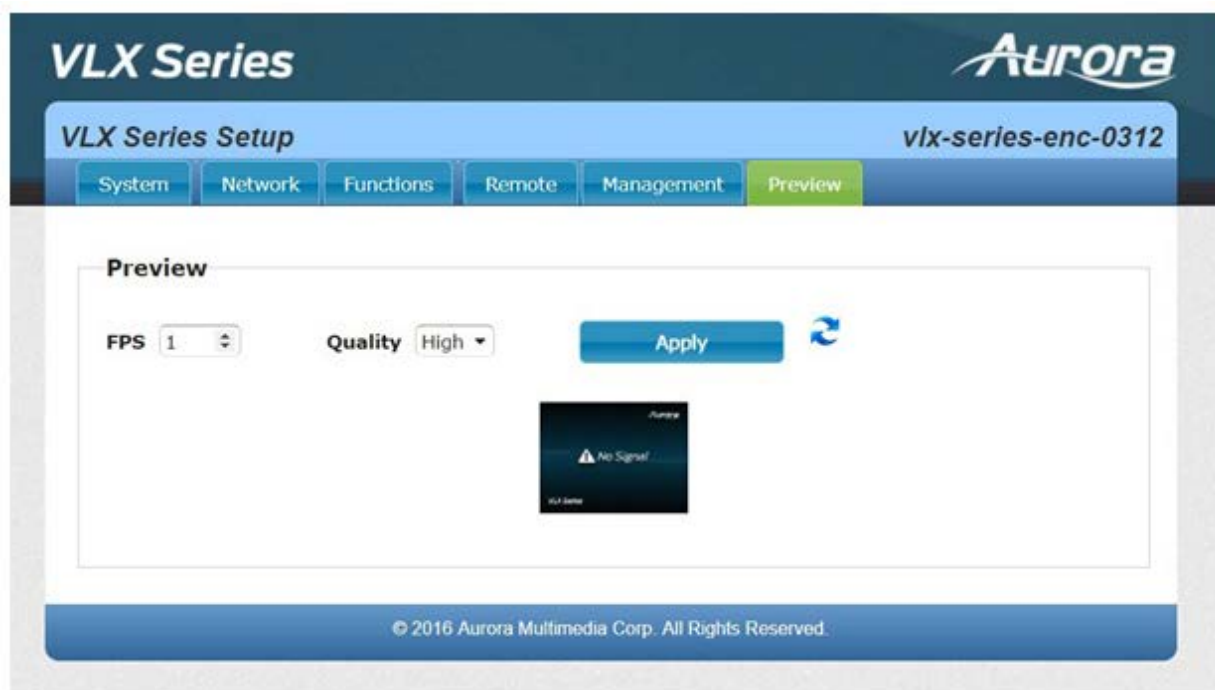

Decoder Mode Web Pages

System Tab

The System Tab has 5 selections of Version Info, Updating of Firmware, Utilities, Statistics, and Remote.

Hardware Information

Shows the Units MAC Address, Serial Number, and Mode.

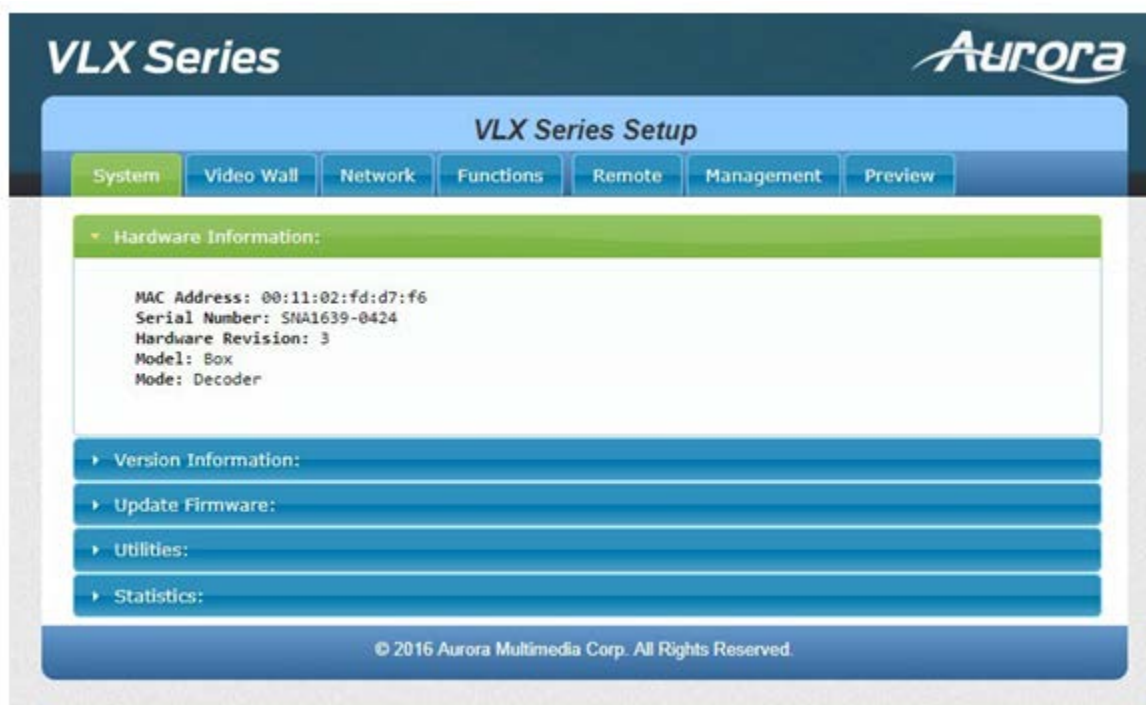

Version

Version reports back the current firmware version. This will help to not only make choices for updating firmware if necessary, but by knowing the firmware the user will know the current capabilities that can be expected of the unit.

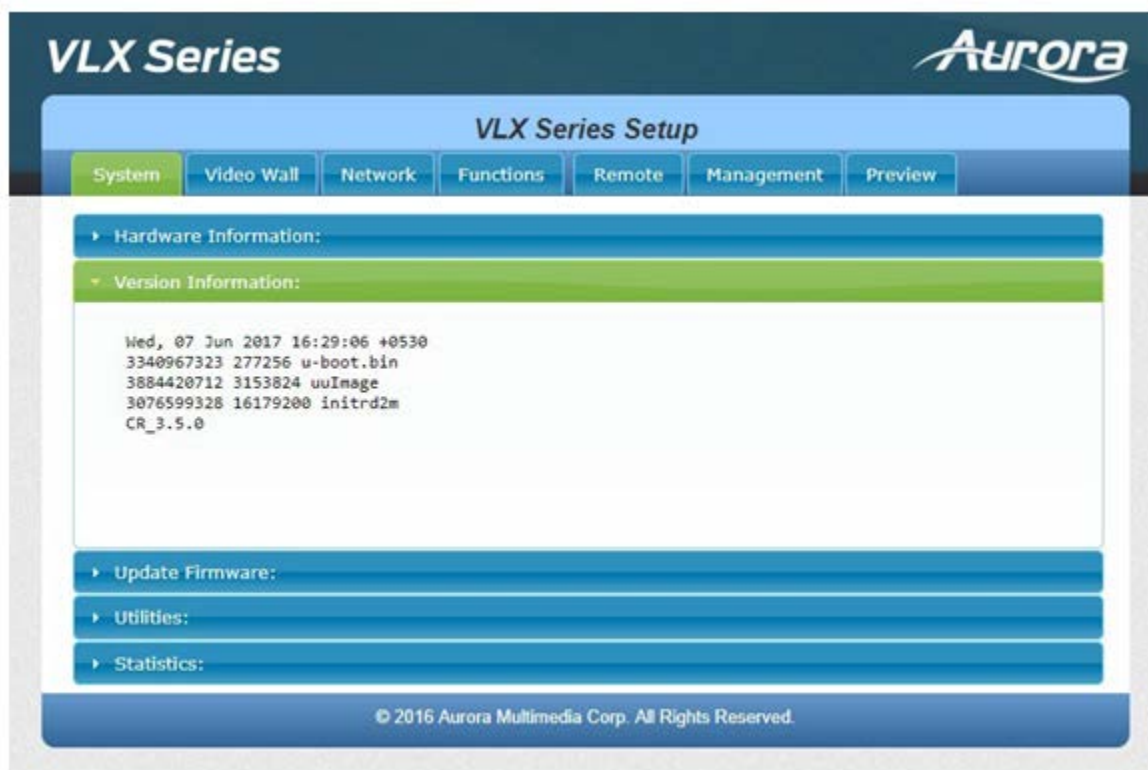

Update Firmware

If updating firmware is necessary, this selection allows a user to select the firmware file and upload to the unit. When the process is done, a notification will appear.

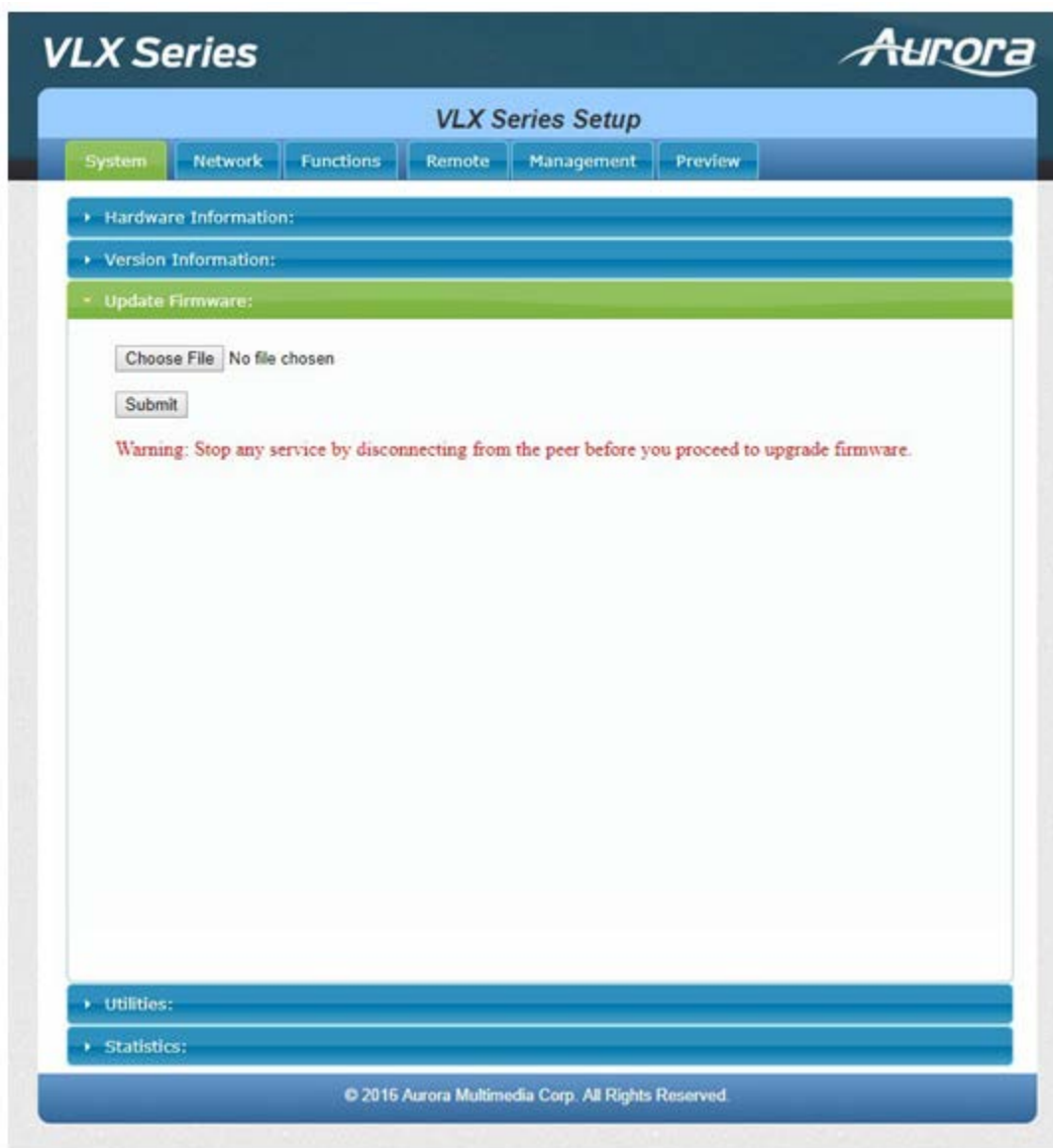

The screenshot displays the 'VLX Series Setup' web interface. At the top, the 'VLX Series' logo and 'Aurora' logo are visible. Below the title bar, there are navigation tabs: 'System' (highlighted), 'Network', 'Functions', 'Remote', 'Management', and 'Preview'. The main content area is divided into sections: 'Hardware Information:', 'Version Information:', 'Update Firmware:', 'Utilities:', and 'Statistics:'. The 'Update Firmware:' section is highlighted in green and contains a file selection area with a 'Choose File' button and the text 'No file chosen', followed by a 'Submit' button. A red warning message reads: 'Warning: Stop any service by disconnecting from the peer before you proceed to upgrade firmware.' At the bottom of the interface, a copyright notice states: '© 2016 Aurora Multimedia Corp. All Rights Reserved.'

Utilities

The selection allows factory defaults, remote rebooting, resetting of EDID, as well as the ability to manually enter API commands.



Statistics

This selection is very useful when diagnosing the unit as it reveals important information about the unit itself. Everything from MAC, IP, EDID detail, Video Timing and more is all available to help see the state of the unit.

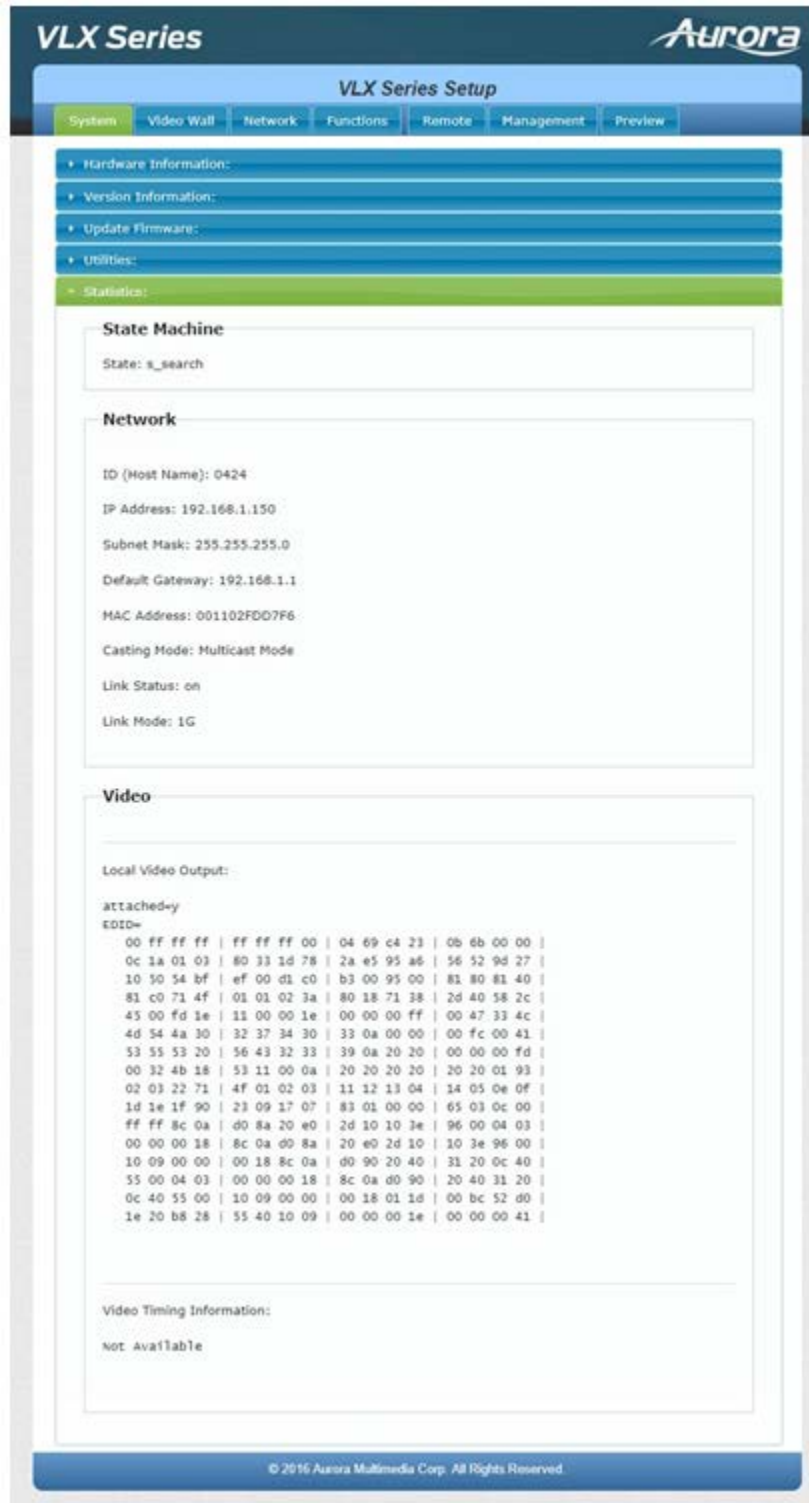

The screenshot shows the 'VLX Series Setup' web interface. The 'Statistics' tab is selected and highlighted in green. The interface displays the following information:

- State Machine:** State: s_search
- Network:**
 - ID (Host Name): 0424
 - IP Address: 192.168.1.150
 - Subnet Mask: 255.255.255.0
 - Default Gateway: 192.168.1.1
 - MAC Address: 001102FDD7F6
 - Casting Mode: Multicast Mode
 - Link Status: on
 - Link Mode: 1G
- Video:**
 - Local Video Output:
 - attached-y
 - EDID=

```

00 ff ff ff | ff ff ff 00 | 04 69 c4 23 | 06 6b 00 00 |
0c 1a 01 03 | 80 33 1d 78 | 2a e5 95 a6 | 56 52 9d 27 |
10 50 54 bf | ef 00 d1 c0 | b3 00 95 00 | 81 80 81 40 |
81 c0 71 4f | 01 01 02 3a | 80 18 71 38 | 2d 40 58 2c |
45 00 fd 1e | 11 00 00 1e | 00 00 00 ff | 00 47 33 4c |
4d 54 4a 30 | 32 37 34 30 | 33 0a 00 00 | 00 fc 00 41 |
53 55 53 20 | 56 43 32 33 | 39 0a 20 20 | 00 00 00 fd |
00 32 4b 18 | 53 11 00 0a | 20 20 20 20 | 20 20 01 93 |
02 03 22 71 | 4f 01 02 03 | 11 12 13 04 | 14 05 0e 0f |
1d 1e 1f 90 | 23 09 17 07 | 83 01 00 00 | 65 03 0c 00 |
ff ff 8c 0a | d0 8a 20 e0 | 2d 10 10 1e | 96 00 04 03 |
00 00 00 18 | 8c 0a 00 8a | 20 e0 2d 10 | 10 3e 96 00 |
10 09 00 00 | 00 18 8c 0a | 00 90 20 40 | 31 20 0c 40 |
55 00 04 03 | 00 00 00 18 | 8c 0a 00 90 | 20 40 31 20 |
0c 40 55 00 | 10 09 00 00 | 00 18 01 1d | 00 bc 52 00 |
1e 20 b8 28 | 55 40 10 09 | 00 00 00 1e | 00 00 00 41 |
                
```
- Video Timing Information: not Available

© 2016 Aurora Multimedia Corp. All Rights Reserved.

Video Wall Tab

The Video Wall tab is comprised of the basic and advanced selections.

Basic

Basic selection has the controls for a user to setup a video wall very easily by entering the active area and the total area. The VLX will figure out the proper slicing of the image based on this information and position/layout.

The screenshot displays the 'VLX Series Setup' web interface. At the top, there's a navigation bar with tabs for System, Video Wall, Network, Functions, Remote, Management, and Preview. The 'Video Wall' tab is selected. Below the navigation bar, the 'Basic Setup' section is expanded, showing three main configuration areas:

- Bezel and Gap Compensation:** This section includes four input fields for OW, OH, VW, and VH, each with the value '1'. To the right is a diagram of a single monitor unit with dimensions OW (Outer Width), OH (Outer Height), VW (View Width), and VH (View Height) indicated by dashed lines and arrows. The text 'UNIT: 8.1mm' is located below the diagram.
- Wall Size and Position Layout:** This section features four dropdown menus: 'Vertical Monitor Count' (set to 1), 'Horizontal Monitor Count' (set to 1), 'Row Position' (set to 0), and 'Column Position' (set to 0). To the right is a diagram showing a grid of monitor units with labels for 'Horizontal Monitor Count' and 'Vertical Monitor Count'. The text 'UNIT: Panel' is located below the diagram.
- Preferences:** This section contains two dropdown menus: 'Stretch Type' (set to 'Fit In') and 'Clockwise Rotate' (set to 0).

At the bottom of the 'Basic Setup' section, there is an 'Apply To' dropdown menu set to 'This' device connected by your browser, an 'Apply' button, and a checkbox for 'Show OSD' which is currently unchecked. Below the 'Basic Setup' section, the 'Advanced Setup' section is partially visible. The footer of the interface contains the copyright notice: '© 2016 Aurora Multimedia Corp. All Rights Reserved.'

Advanced

Advanced selection has the controls for a user to do more custom controls of the video wall, including image rotation.

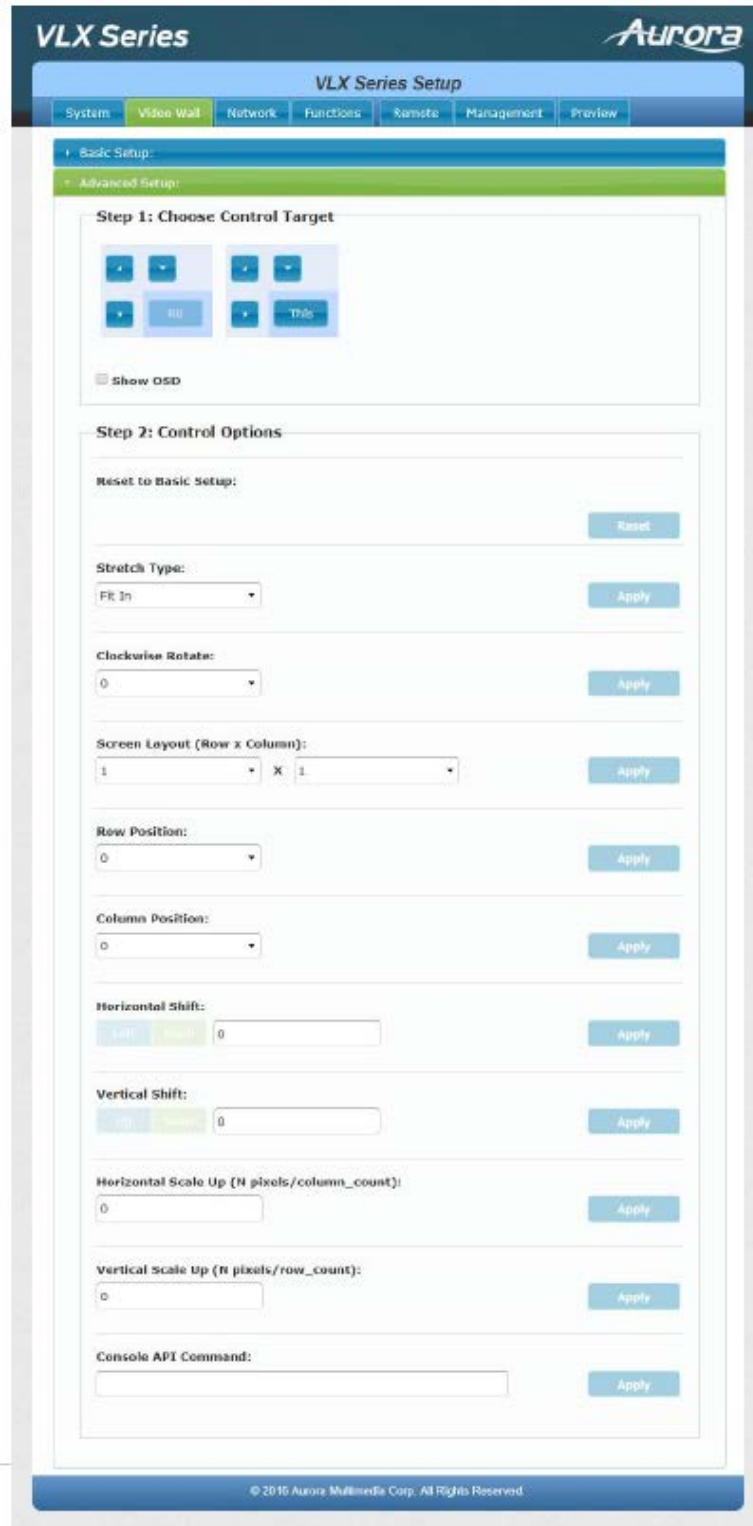

Network Tab

The Network tab allows the setup of the IP address, Subnet, and Gateway. In addition, the mode of point to point (Unicast) or matrixing (Multicast) can be selected under Casting mode.

The screenshot shows the 'VLX Series Setup' interface with the 'Network' tab selected. The interface includes a navigation bar with tabs for System, Video Wall, Network, Functions, Remote, Management, and Preview. The 'IP Setup' section contains three radio buttons for IP Mode: Auto IP, DHCP, and Static (which is selected). Below this are input fields for IP Address (192.168.1.150), Subnet Mask (255.255.255.0), and Default Gateway (192.168.1.1), each with an 'Apply' button. The 'Host ID' section has an input field containing '0424' and an 'Apply' button. The 'Host Name' section has an input field containing 'vlx-series' and an 'Apply' button. A footer at the bottom of the interface reads '© 2016 Aurora Multimedia Corp. All Rights Reserved.'

Functions Tab

The Functions tab has selections pertaining to the Video over IP, Maximum bit Rate which is useful for bandwidth restricted networks, and USB over IP settings,

VLX Series

VLX Series Setup

System Video Wall Network **Functions** Remote Management Preview

Video over IP

Enable Video over IP

Enable Video Wall

Scaler Output Mode: Pass-Through

Timeout for Detecting Video Lost: 10 seconds

Turn off screen on video lost

Apply

USB over IP

Enable USB over IP

Compatibility Mode:

K/M over IP (Uncheck when mouse/keyboard/touch panel not working as expected)

Apply

© 2016 Aurora Multimedia Corp. All Rights Reserved.

Remote Tab

The Remote tab allows the selection of the encoder to route to the unit.

The screenshot shows the 'VLX Series' configuration interface with the 'Remote' tab selected. The interface includes a navigation bar with tabs for System, Video Wall, Network, Functions, Remote, Management, and Preview. The 'Remote' tab is active, showing the 'VLX Series Setup' for unit 'vlx-series-dec-0211'. The 'Remote Connection' section has an 'Apply To:' dropdown set to '0312:vlx-series-enc-031', with 'Apply', 'Send EDID', and 'Disconnect' buttons. The 'IR Auto Pair' toggle is turned on. The 'Genlock Mode' section has 'Enable Genlock mode' checked, with an 'Apply' button. The 'Serial over IP' section has 'Enable Serial over IP' checked, 'Operation Mode' set to 'Redirection', and 'Redirect to:' set to 'vlx-series-enc-0312'. The 'Baudrate Setting' section has 'Baudrate' at 115200, 'Data bits' at 8, 'Parity' at None, and 'Stop bits' at 1. An 'Apply' button is at the bottom right. A footer contains the copyright notice: © 2016 Aurora Multimedia Corp. All Rights Reserved.

Management Tab

The Management tab manages routing of streaming video sources and mode selection and configuration of serial over IP settings.

The screenshot shows the 'VLX Series Setup' interface for the device 'vlx-series-dec-0211'. The 'Management' tab is selected, and the 'Bitmap/Channel Map' section is active. It features a file selection dropdown (currently 'wait.jpg'), 'Apply', 'Delete', and 'Erase Disk' buttons. Below this is an 'Upload' button and a 'Disk space used' indicator at 5%. The 'Channel Map - Front Panel Button' section has radio buttons for 'Enable' and 'Disable' (selected), with an 'Apply' button. The 'Channel Map - IR Remote' section has radio buttons for 'OFF', 'Aurora IRC11', and 'Philips 10054', with an 'Apply' button. The 'Update Settings' section includes a 'Settings Type' dropdown (set to 'Recovery') and a 'Config File Name' field with a 'Choose File' button and 'No file chosen' text, followed by an 'Upload' button. The 'Backup Settings' section contains a 'Download' button.

Authentication Settings

Enable Disable

New User Name:

New User Password:

Confirm Password:

© 2016 Aurora Multimedia Corp. All Rights Reserved.

Preview Tab

The Preview tab allows you to look at the active video output.

VLX Series

VLX Series Setup

System Video Wall Network Functions Remote Management **Preview**

VLX-Preview

© 2016 Aurora Multimedia Corp. All Rights Reserved.

APPLICATIONS

Example 1: VLX-TCW2 Configured as Transmitter to VLX-TC1 Configured Receiver

When the VLX Series is connected point to point, no configuration is required, as the units will auto identify and make a tunnel between both ends for the video, audio, RS-232, IR, USB, and Ethernet. With the copper version a maximum distance of 100m (328ft) can be achieved.

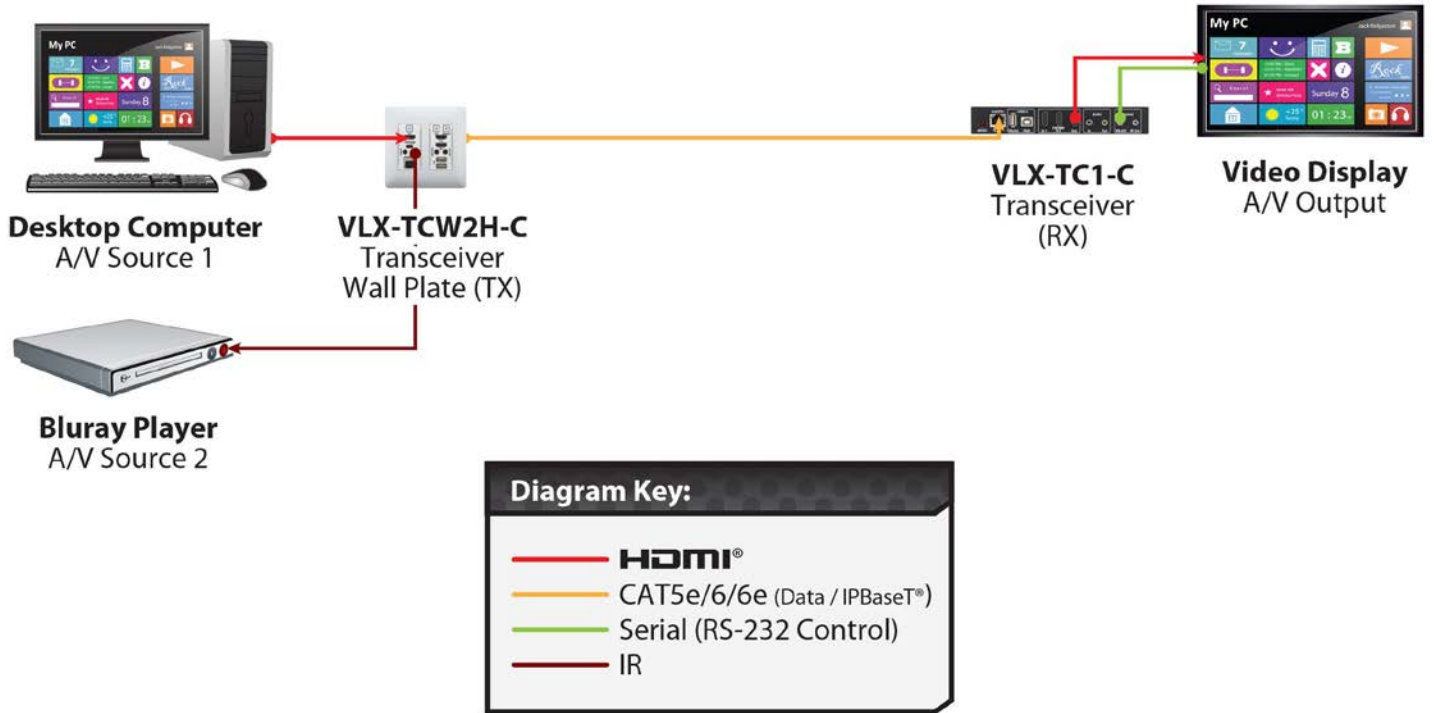

Example 2: VLX Multi-Room

The VLX Series is perfect for multi-room applications with its flexibility. A nearly unlimited number of rooms can share video, audio, data, and control in real-time. The scalability is only limited by the size of the network switch and infrastructure.

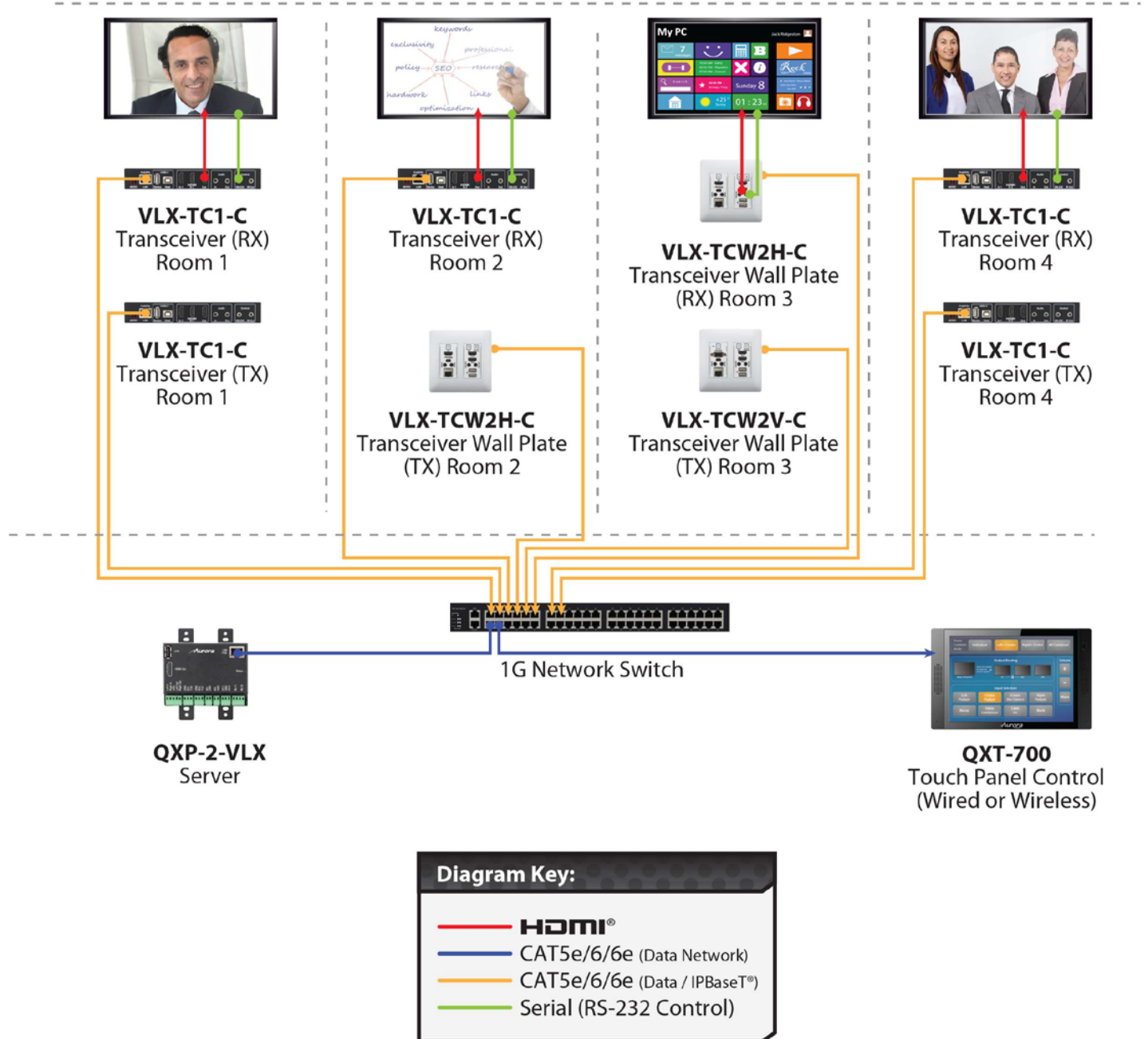

Example 3: Matrix – Multiple VLX to Multiple VLX

The VLX can take the place of any typical card cage matrix system, adding flexibility and performance never seen before. Even features like Fast-switch is no longer a premium.

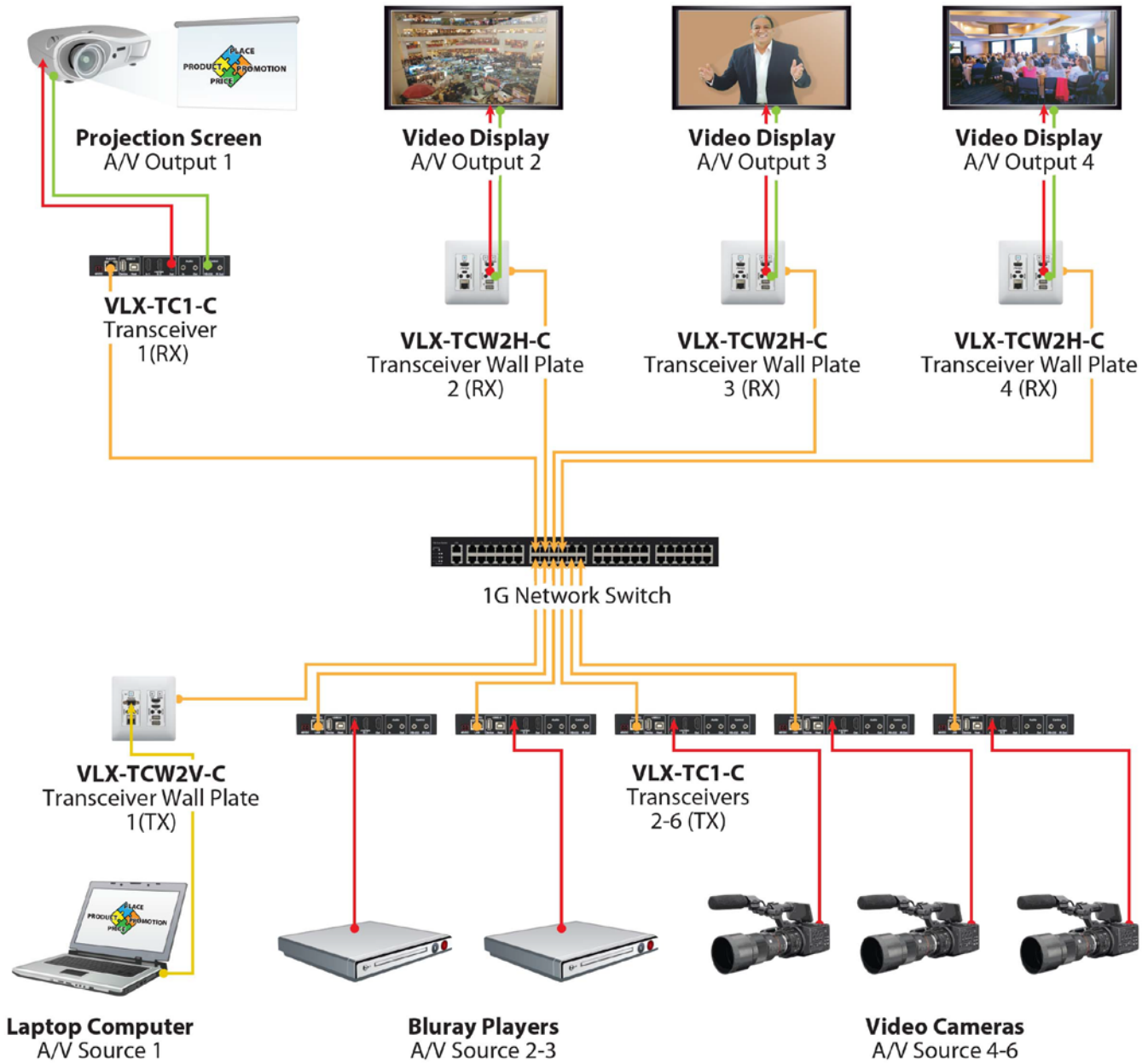
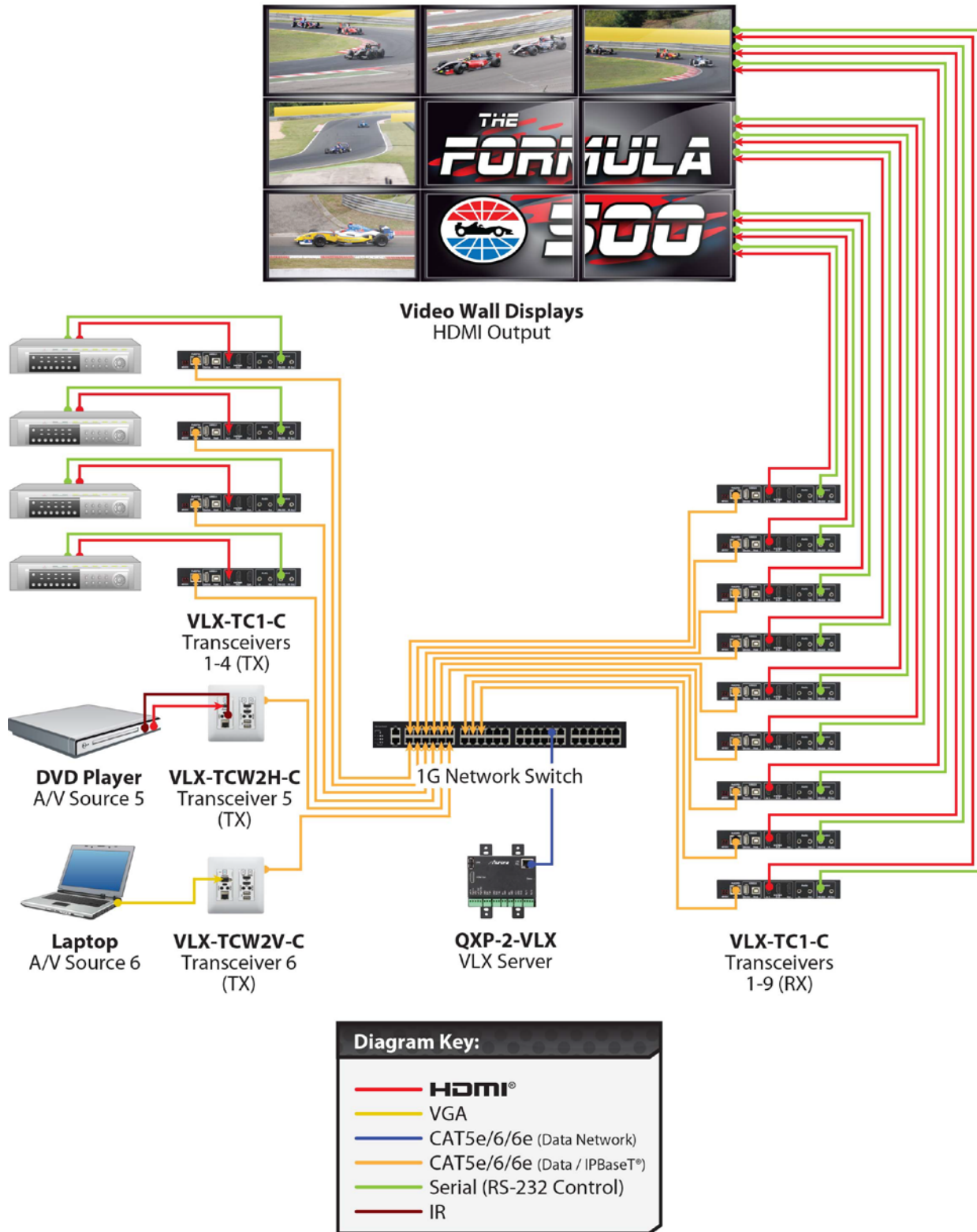

Diagram Key:	
	HDMI®
	VGA
	CAT5e/6/6e (Data / IPBaseT®)
	Serial (RS-232 Control)

Example 4: Video Wall

The VLX Series is capable of 4K video walls. Up to 8x8 size can be created with 4K input.



Example 5: KVM Utilizing USB 2.0

Command & Control and NOC centers are perfect for the VLX Series, especially with the USB 2.0 running at a full 50Mbps. With the VLX it is no longer just keyboard and mouse but full USB peripheral routing as well.

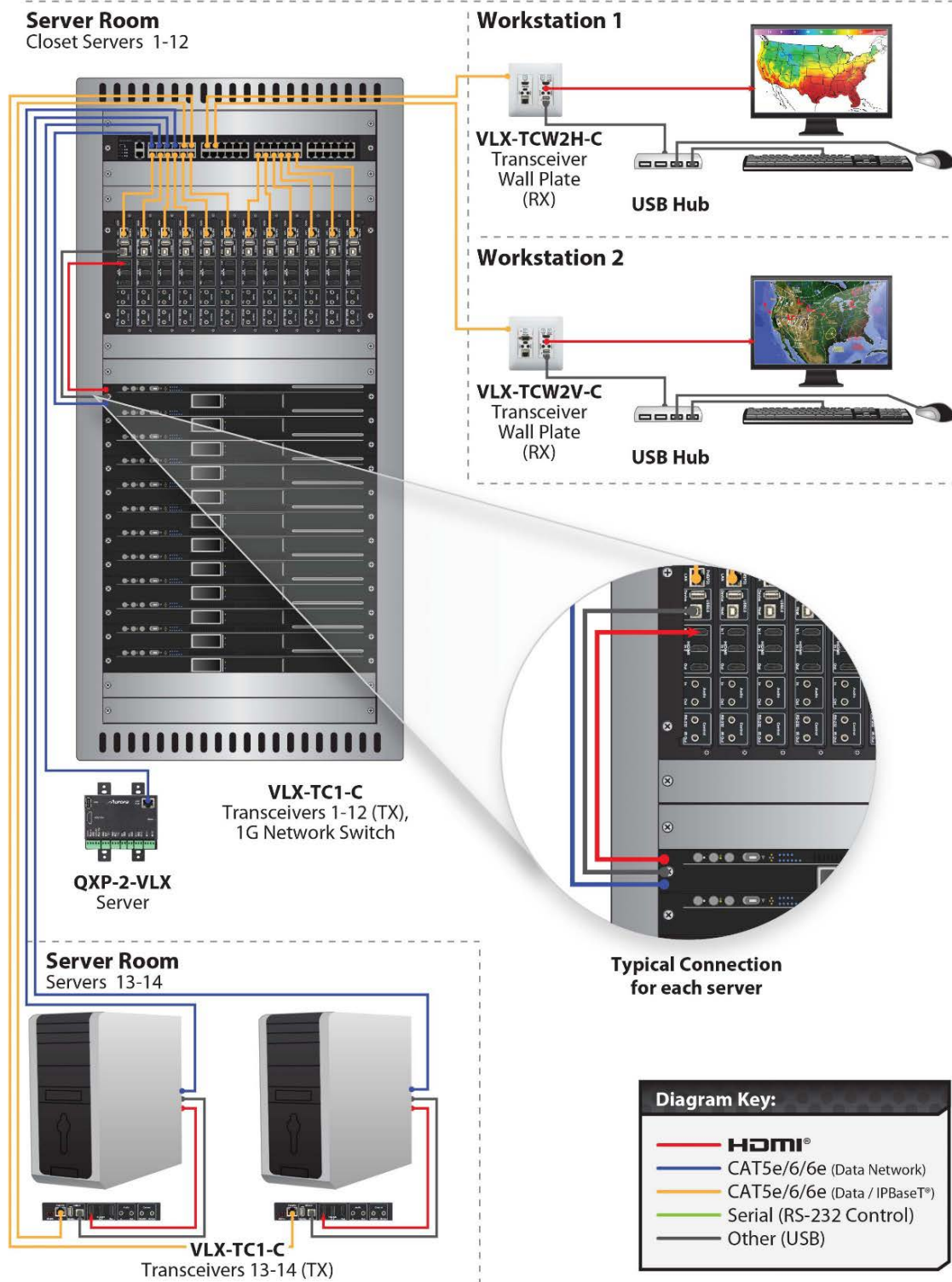

Example 6: VLX-TC1-CF with Local Ethernet Control

Using the SFP a multimode fiber, single-mode fiber, or RJ-45 Copper, the VLX can connect to an ethernet switch and to a local device that requires Ethernet. If a copper switch is used with PoE the same can be accomplished by using the main RJ-45 to power and the SFP to do the local control.

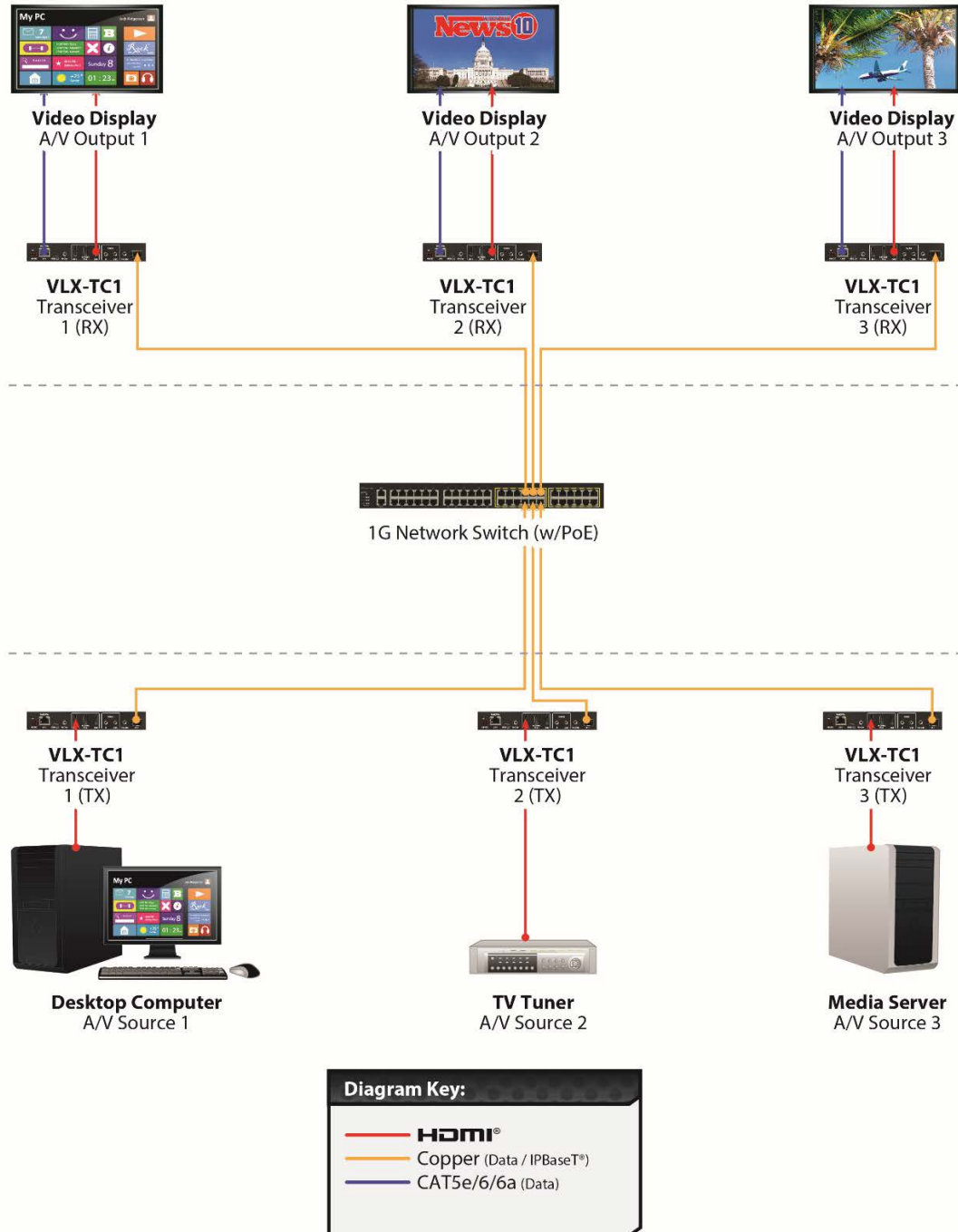

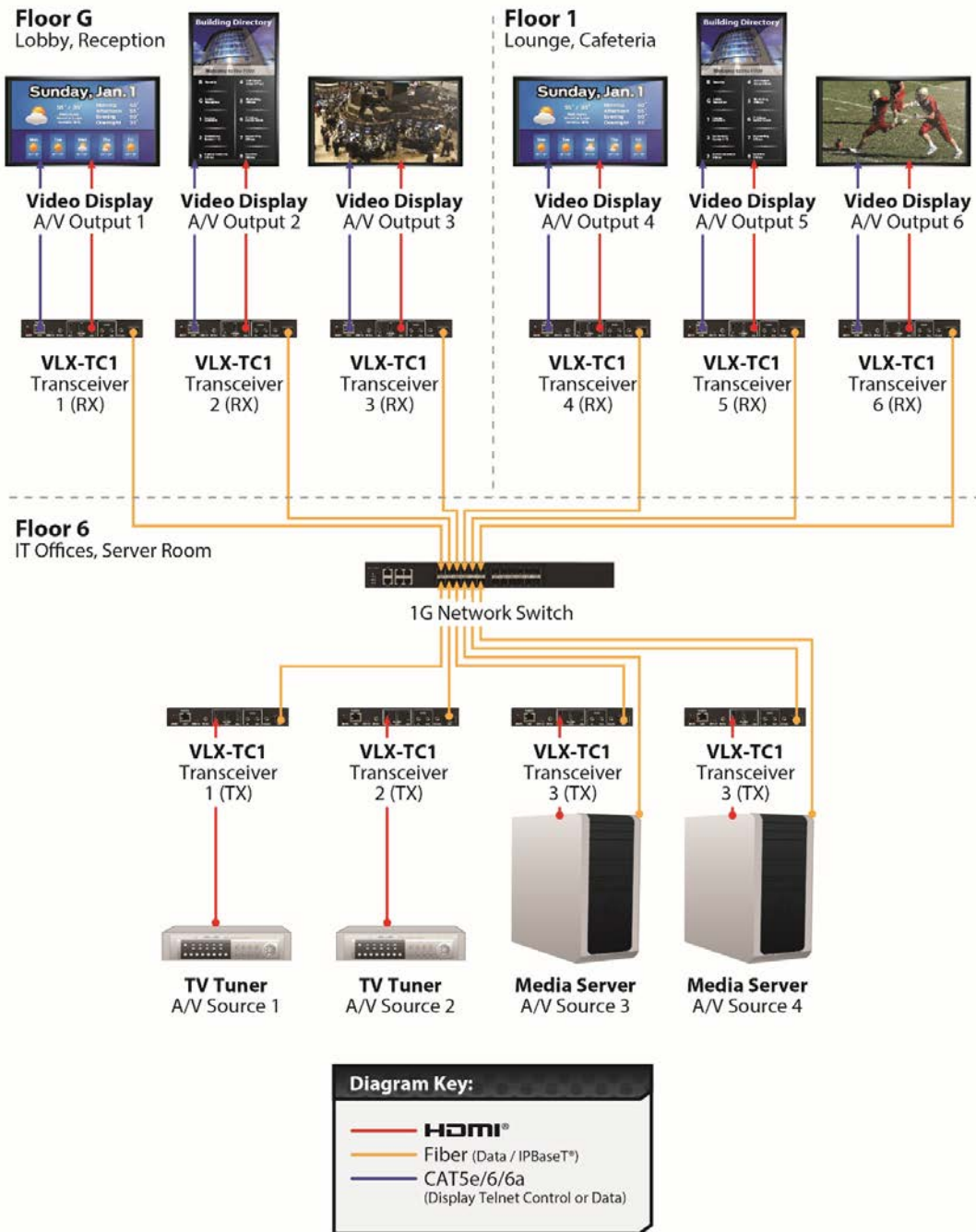

Example 7: VLX-TC1-CF Daisy Chain

The VLX-TC1-CF can be used in a Daisy chain mode with RJ-45 to RJ-45 or a mix of fiber. Note when using daisy chain only the first unit can be power by PoE. Following units would require local power. If a unit in the chain is not power or has an issue the remaining units in the chain will no longer function.

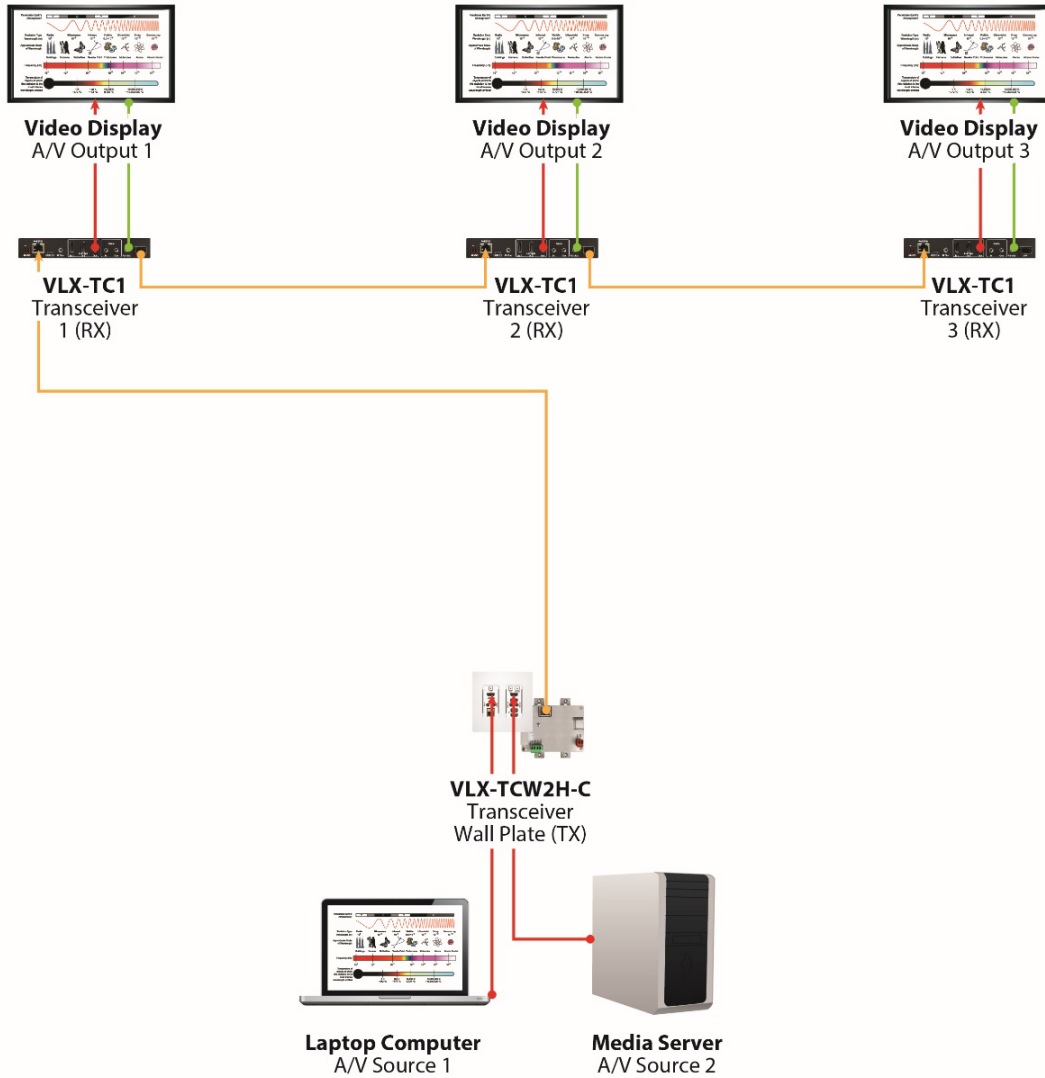
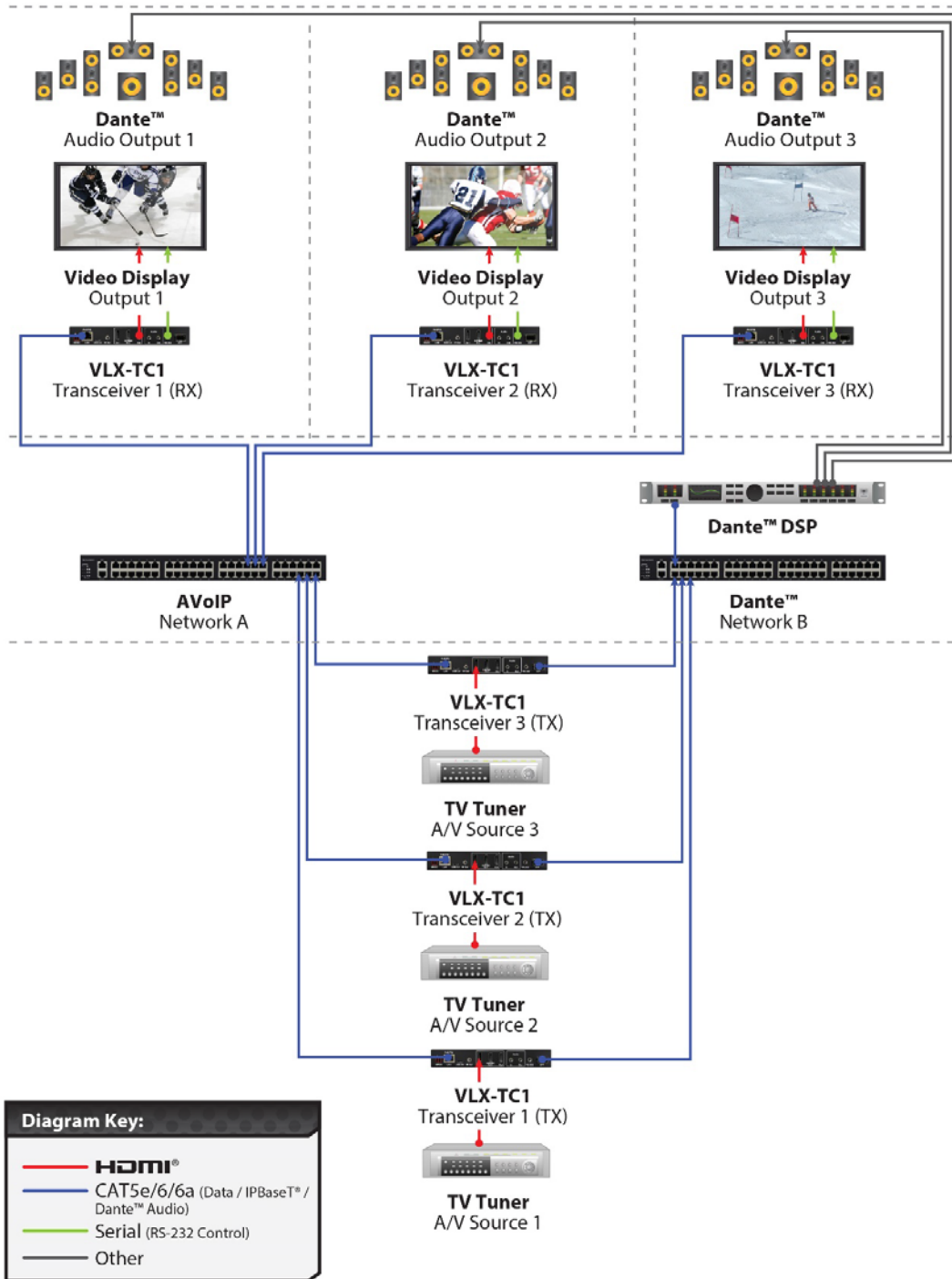

Diagram Key:

- **HDMI®**
- **CAT5e/6/6a (Data / IPBaseT®)**
- **Serial (RS-232 Control)**

Example 8: VLX-TC1-CF Independent Dante®/AES67 Switch

In some cases, it may be desired to have the Dante® on its own Ethernet Switch. The VLX-TC1-CF has a mode allowing the traffic of the Dante®/AES67 to only be assigned to one of the 2 LAN ports.



SOFTWARE

IPBaseT Manager PC Control Tool

The IPBaseT Manager is a Windows® based software available at the Aurora customer portal on www.auroramm.com.

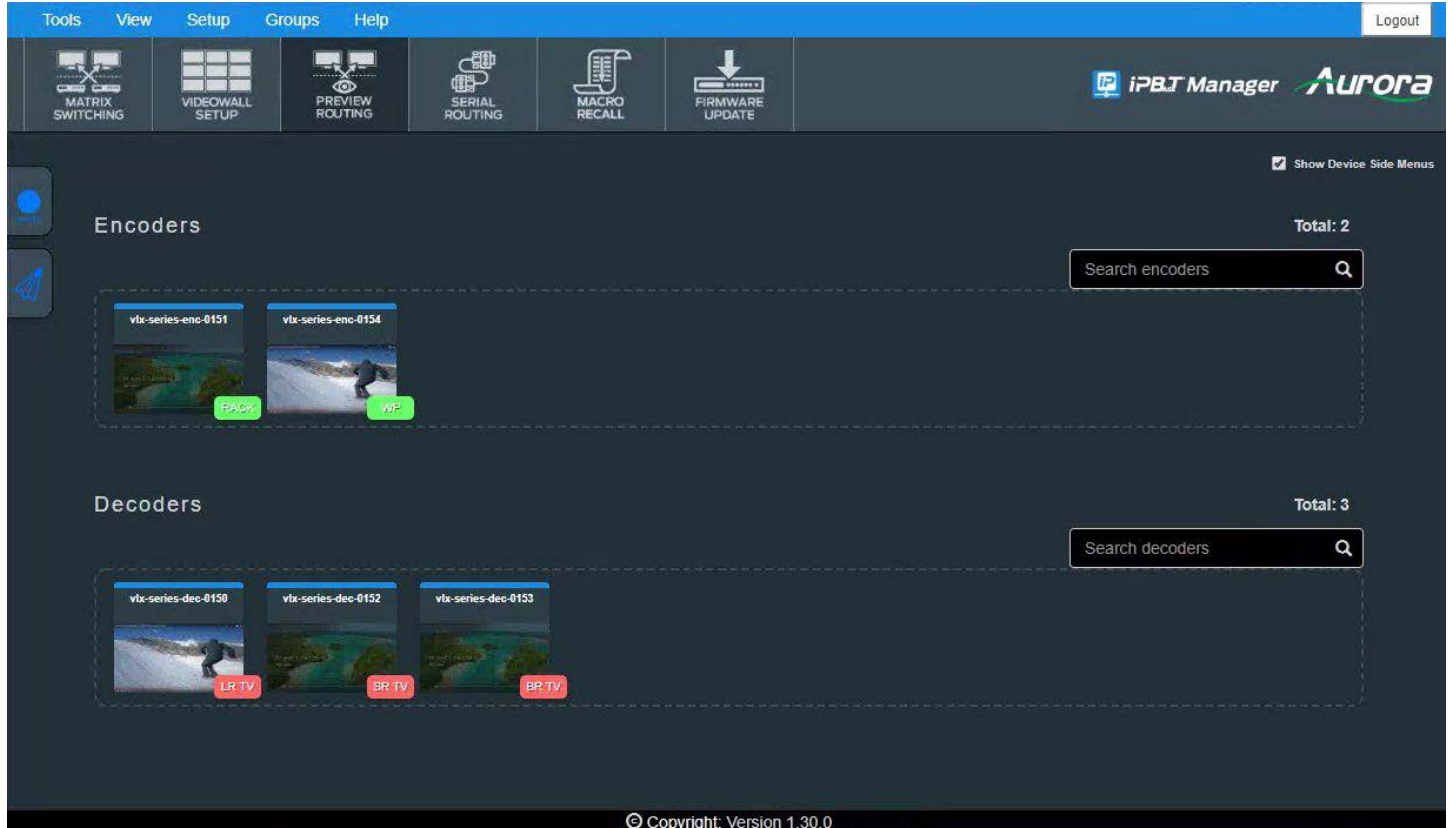

IPBaseT Manager allows a user to control the various capabilities of VLX series products on a network. While the IPBaseT manager is client software, the IPBaseT Server handles all the communication handling and is the target for all communication. This allows for centralized communications and the ability to run many clients on a network seamlessly. The VLX can also work decentralized as well for smaller installations.

Features

- Matrix Switching
- Video Wall Setup and Control
- RS-232 Routing and Control
- IR (Infrared) Remote Control Routing
- Horizontal and Vertical Viewing
- Macro Store and Recall
- Connection Manager

- Advanced Debug Logging
- Touch Screen Friendly Layout
- Configuration File for Cloning Presets and Connections on Other PCs
- Firmware Updating
- High-Resolution Previews
- Macro Recording
- Light/Dark Themes
- Embedded User Guide
- User Logging and Profiles
- Device Grouping
- Tagging
- Preview routing
- EDID editor
- Rapid deployment tool
- Touch screen/mobile friendly layout
- User and group management
- Macro recording

For full detail of the IPBaseT Manager Software tool and setup, the manual can be found at the Aurora website www.auroramm.com.

CONNECTOR PIN DEFINITION

HDMI

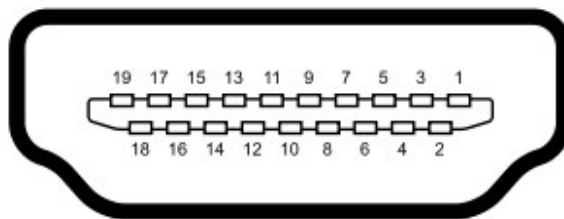

Type A (Receptacle) HDMI

Pin 1	TMDS Data2+	Pin 8	TMDS Data0 Shield	Pin 15	SCL
Pin 2	TMDS Data2 Shield	Pin 9	TMDS Data0-	Pin 16	SDA
Pin 3	TMDS Data2-	Pin 10	TMDS Clock+	Pin 17	DDC/CEC Ground
Pin 4	TMDS Data1+	Pin 11	TMDS Clock Shield	Pin 18	+5 V Power
Pin 5	TMDS Data1 Shield	Pin 12	TMDS Clock-	Pin 19	Hot Plug Detect
Pin 6	TMDS Data1-	Pin 13	CEC		
Pin 7	TMDS Data0+	Pin 14	Reserved (N.C. on device)		

CAT5e/6/6A

T568A and T568B Wiring

Pin	T568A Pair	T568B Pair	Wire	T568A Color	T568B Color	Pins on plug face (socket is reversed)
1	3	2	tip	white/green stripe	white/orange stripe	
2	3	2	ring	green solid	orange solid	
3	2	3	tip	white/orange stripe	white/green stripe	
4	1	1	ring	blue solid	blue solid	
5	1	1	tip	white/blue stripe	white/blue stripe	
6	2	3	ring	orange solid	green solid	
7	4	4	tip	white/brown stripe	white/brown stripe	
8	4	4	ring	brown solid	brown solid	

RS-232

The RS-232 is a 3.5mm TRS connector. Tip is TX (output), ring is RX (input), and Sleeve is ground. To simplify connections Aurora offers pre-molded RS-232 cables in null and none nulled in male and female DB9.

CA0052 Selection Guide

CA0052 (all versions) TRS Male



CA0052-F2T3R DB9 Female (Crossover)

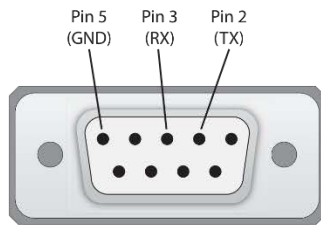

CA0052-F3T2R DB9 Female (Straight)

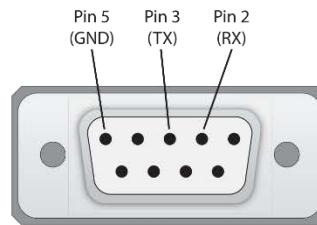

CA0052-M2T3R DB9 Male (Crossover)

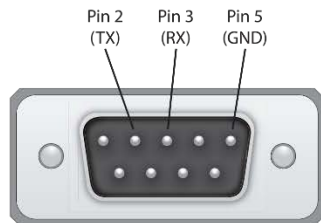

CA0052-M3T2R DB9 Male (Straight)

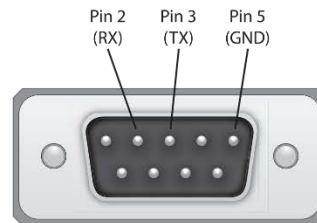

IR (Infrared)

It will autosense a TS or a TRS connector to determine if an IR emitter (TS) or IR receiver (TRS) is inserted. The IR receiver must be with carrier inverted to work. The tip is signal, ring is 5V, and sleeve is ground.

IR Receiver CA0026-1 (30kHz – 60kHz)



IR Receiver CA0026-1 (30kHz – 60kHz)



APPENDIX 1

Troubleshooting

It is advisable to make certain all units are using the latest firmware before troubleshooting. Also make sure all network connections are operating on 1G.

VLX Web Server is Not Responding

- Make certain every VLX unit has a unique IP Address set for the webserver. Disconnect unit from 1G network and connect PC directly to 1G LAN and check to see if webserver appears in browser. If not trying restoring defaults and try again. Repeat this for every unit. Another method is using the server to issue commands to change the webserver IP settings over the 1G.

Display Will Not Show a Picture

- All devices are powered on.
- Unit is set properly for Decoder. LED status will show this.
- Check routing with IPBaseT Manager.
- A picture is achieved when connecting the source directly to the display.
- Display is set to the correct signal source input mode using display's remote. Example, switching to HDMI 1 if HDMI 1 interface is connected to the RX via a HDMI cable.
- All the cables are qualified.
- The Switch supports IGMP snooping and this function is enabled.
- Look at status LED and make certain unit is linked. The enter button on the front changes the link status.

Display Has Image with Wrong Color

- Make certain to learn the EDID from the display and save into each unit HDMI input ports.
- If different displays are used with the same source, an EDID with a common denominator must be used. For example, if on destination is 4K UHD and the other is 1080p and the 4K EDID is utilized, the 1080p screen will not get an image if the source is 4K capable. In this case it would be better to use a 1080p EDID.

Audio Not Working

- Make certain correct audio path is selected. The IPX can choose between analog input and HDMI.
- Verify correct EDID usage. If EDID has 5.1 surround sound listed and display cannot do 5.1 there will be no audio. Lack of EDID will also cause a source to output DVI which lacks audio.
- Check volume on display or amplifier.

VLX RS-232 Control is Not Working

- Check wiring for RX, TX, and Ground. (VLX 3.5mm Tip is TX, Ring is RX, Sleeve is GND).
- Check the baud rate of the unit.

- Confirm the protocol being utilized with a terminal program.
- Ensure the proper serial control mode is selected (SoIP).

Routing a Source to Multiple Displays is Tearing

- Check network switch is properly configured for IGMP and supports Jumbo packets. VLX requires Jumbo/MTU Packet of 8192 or better for full 4K video streaming.

VLX Server is Responding Poorly

- Check network switch is properly configured for IGMP with snooping.

Displays Not Showing Same Video Frame as Others

- If displays are different brands this can happen as depending on the scaler circuitry utilized inside the display and the amount of buffering used.
- If displays are different brands trying using same native resolution of the displays. Some displays will not scale or use memory and just sync to the native signal.

Audio is Different Between Displays or the Analog Output

- If displays are different brands this can happen based on the design. It is always ideal to use same models for consistency or a central source for audio to keep in sync.

APPENDIX 2

Firmware Update

For the latest firmware updates please go www.auroramm.com.

You must be signed up to the Customer Portal in order to download firmware with instructions on how to update.

****Note: Aurora suggests using IPBaseT Manager for performing batch firmware updates. IPBaseT Manager will download the latest VLX firmware when the program is installed or updates.***

APPENDIX 3

Protocol

For the latest protocol please go www.auroramm.com.

You must be signed up to the Customer Portal in order to download IPX protocol. The protocol is only available to authorized Aurora dealers.

APPENDIX 4

Recommended Cabling

Cat 5e UTP (Unshielded): 100m (330ft)

Any brand on the market made to Category 5e or better specification.

Cat 6 UTP (Unshielded): 143m (470ft)

Cable Brand: West Penn Wire

Part Number: 4246. Cat 6 UTP CMR Part Number: 254246. Cat 6 UTP CMP

Cat 6A UTP (Unshielded): 182m (600ft)

Cable Brand: West Penn Wire

Part Number: 4246A. Cat6 A UTP CMR Part Number: 254246A. Cat6A UTP CMP

APPENDIX 5

Recommended Network Switches

The VLX will work with most non-blocking, IGMP, Jumbo packet 1Gbps network switch. Layer 3 will allow more control; however, Layer 2 will work as well. It is highly recommended to communicate with the representative of the desired network switch brand to confirm configuration and capabilities. Below are some models that have been tested with the VLX Series.

Switch Speed

The VLX Series requires the switch to be a 1GbE.

VLX Series technology is used to transmit visually lossless 8:1 compress video up to 4K along with other AV signals such as audio, USB and control signals. For video alone, it means raw bandwidth of about 218Mbps average/850Mbps peak for 4K and that is just for audio and video. It is therefore easy to understand why the VLX requires 1GbE network switches.

Packets Routing

To enable the transmission of a source to multiple destinations, VLX devices make use of Multicast. The default behavior of layer 2 Ethernet switch is to broadcast those packets which mean that every packet will be transmitted to all possible destinations. This is why any network switch used with VLX Series has to support IGMP Snooping. VLX end points use IGMP protocol to assign the end points into multicast groups and the router uses IGMP snooping to efficiently route multicast packets only to receivers that want to receive them.

Many switches have the IGMP Snooping feature disabled by default and manual configuration is required. Often, a simple check mark near “Enable IGMP Snooping” is the only thing needed to enable IGMP Snooping. However, the implementation of IGMP Snooping is vendor specific and additional configuration is often needed.

An Ethernet switch can be informed that a device wants to leave a multicast channel by sending it an IGMP LEAVE GROUP packet. Once received, the time it takes for the switch to apply the new configuration may vary from one switch to the other. Most switches implement and include FASTLEAVE configuration option. When enabled, it takes much less time for a particular port to leave a multicast group to assign the port to a different multicast group. The end results are a noticeably shorter video switching time. Aurora recommends to always enable the FASTLEAVE option when available.

Ethernet Switch Configuration

The following list includes all network switch configuration options that Aurora Engineers have come across so far. Look for these or similar options when configuring your switch.

1. Enable IGMP Snooping
 - a. Must be enabled.
2. Enable IGMP Snooping on VLAN 1
 - a. Must be enabled when all ports default to VLAN1.
3. Filter/Drop Unregistered Multicast Traffic
 - a. If not applied, the behavior of the switch will be to broadcast multicast packets if the switch has no known destination for that packet.
 - b. Must be enabled if found.

4. Unregistered Multicast Flooding
 - a. Must be disabled if found.
5. Filter Unregistered Multicast (different wording than number 4 above)
 - a. Must be enabled if found.
6. Enable IGMP Query
7. Enable IGMP Query on VLAN1
8. Set IGMP Version to IGMP V2
 - a. Must be set if found.
9. Enable FASTLEAVE on Port X
 - a. This is optional. Should be enabled, if found.
10. Enable FASTLEAVE for VLAN1
 - a. This is optional. Should be enabled if found.
11. Jumbo/MTU Packets should be standard function but if not it must be enabled. VLX requires Jumbo/MTU Packet of 8192 or better for full 4K video streaming.

PoE (Power over Ethernet)

The VLX Series uses around 6 watts of power, however, the PoE is unclassified for up to 12.9 watts (15.4 Watts Total) as the USB on the VLX can supply up to 5 watts. When selecting a PoE switch always make certain the power supply of the PoE switch is proper to the port count (15.4W x qty of ports). For example, a 24 port PoE switch must have at least 369.6 Watts (24 at 15.4W) for it to properly supply all 24 VLX devices. Some switches can only supply a certain amount of ports with PoE. If it is necessary to use a particular switch, then PoE injectors for the remaining ports can be used or the local power supply for the VLX but you may need to disable the detection of the PoE for those ports in the Ethernet switch.

APPENDIX 6

Technical Specifications

Model Name	VLX-TC1-CF
Technical	
Compression	8:1
Latency	1.5 Frames (25ms)
HDMI Inputs	2 (HDMI 2.0, HDCP2.2)
HDMI Outputs	1 (HDMI 2.0, HDCP2.2)
Audio Analog	Stereo Line In/Out (3.5mm TRS)
1G Copper Ethernet	RJ-45
LAN	RJ-45 10/100/1000M PoE (PSE)
SFP	1G RJ-45, Single Mode, Multi-Mode
Video Bandwidth	340MHz
Video support	Up to 4K60 4:2:0/4K30 4:4:4
Audio support	Up to 7.1 Channel
RS-232	Up to 115k Baud (3.5mm TRS)
IR Output	3.5mm TRS
USB Connectors	USB 2.0 Type A, 1 USB 2.0 Type B 2 USB 1.1 Type A
Expansion Ports	Dante® Option
Interface	IR or Keypad via OSD, Webserver
Mechanical	
Housing	Black Aluminum Enclosure
Dimensions [L x W x H]	175 x 102 x 27.7mm [6.875" x 4" x 1.09"]
Weight	.453kg [1lbs]
Mounting	Optional: Rack mount vertical, Rack mount horizontal, Under table mount
Power supply	48V DC (2 pin Euro) or PoE (LAN)
Power consumption	6 Watts
Operation temperature	0~40°C [32~104°F]
Storage temperature	-20~60°C [-4~140°F]
Relative humidity	20~90% RH [no condensation]
Package Contents	1x VLX-TC1-CF

***Note: Specifications subject to change without notice.**

Model Name	VLX-TCW2
Technical	
Compression	8:1
Latency	1.5 Frames (25ms)
HDMI Inputs	HDMI 2.0/HDCP2.2 (VLX-TCW2V) HDMI 2.0/HDCP2.2 (VLX-TCW2H)
HDMI Outputs	1 HDMI 2.0/HDCP2.2
VGA/YPbPr Inputs	1 15 Pin HD Female (VLX-TCW2V)
Audio Analog	Stereo Line In/Out (3.5mm TRS)
1G Copper Ethernet	RJ-45
LAN	RJ-45 10/100/1000M PoE (PSE)
Video Bandwidth	340MHz
Video support	Up to 4K60 4:2:0/4K30 4:4:4
Audio support	Up to 7.1 Channel
RS-232	2 qty Up to 115k Baud (3.5mm TRS)
IR	3.5mm TRS
USB Connectors	1 USB 2.0 Type A, 1 USB 2.0 Type B
Expansion Ports	Dante®. Option
Interface	IR or Keypad via OSD, Webserver
Mechanical	
Housing	Aluminum
Dimensions [L x W x H]	2 Gang 3.728" x 2.83"(4.331" with tabs) x 1.404"
Weight	1.13g [2.5lbs]
Mounting	Wall-mounting Decora® 2 Gang
Power supply	48V DC (2 pin Euro) or PoE (LAN)
Power consumption	6 Watts
Operation temperature	0~40°C [32~104°F]
Storage temperature	-20~60°C [-4~140°F]
Relative humidity	20~90% RH [no condensation]
Package Contents	1x VLX-TCW2

***Note: Specifications subject to change without notice.**

APPENDIX 7

Warranty

Limited 5 Year Warranty

Aurora Multimedia Corporation (“Manufacturer”) warrants that this product is free of defects in both materials and workmanship for a period of 5 years as defined herein for parts and labor from date of purchase. This Limited Warranty covers products purchased in the year of 2019 and after. Motorized mechanical parts (Hard Drives, DVD, etc.), mechanical parts (buttons, doors, etc.), remotes and cables are covered for a period of 1 year. Touch screen displays are covered for 1 year; touch screen overlay components are covered for 90 days. Supplied batteries are not covered by this warranty. During the warranty period, and upon proof of purchase, the product will be repaired or replaced (with same or similar model) at our option without charge for parts or labor for the specified product lifetime warranty period.

This warranty shall not apply if any of the following:

- A. The product has been damaged by negligence, accident, lightning, water, act-of-God or mishandling; or,
- B. The product has not been operated in accordance with procedures specified in operating instructions; or,
- C. The product has been repaired and or altered by other than manufacturer or authorized service center; or,
- D. The product's original serial number has been modified or removed; or,
- E. External equipment other than supplied by manufacturer, in determination of manufacturer, shall have affected the performance, safety or reliability of the product; or,
- F. Part(s) are no longer available for product.

In the event that the product needs repair or replacement during the specified warranty period, product should be shipped back to Manufacturer at Purchaser's expense. Repaired or replaced product shall be returned to Purchaser by standard shipping methods at Manufacturer's discretion. Express shipping will be at the expense of the Purchaser. If Purchaser resides outside the contiguous US, return shipping shall be at Purchaser's expense.

No other warranty, express or implied other than Manufacturer's shall apply.

Manufacturer does not assume any responsibility for consequential damages, expenses or loss of revenue or property, inconvenience or interruption in operation experienced by the customer due to a malfunction of the purchased equipment. No warranty service performed on any product shall extend the applicable warranty period. This warranty does not cover damage to the equipment during shipping and Manufacturer assumes no responsibility for such damage. This product warranty extends to the original purchaser only and will be null and void upon any assignment or transfer.



VLX-TC1-CF



VLX-TCW2V-C



VLX-TCW2H-C

Aurora Multimedia Corporation

205 Commercial Court | Morganville, NJ 07751

Phone: 732-591-5800 | Fax: 732-591-6801