



# 3000 Digital Series

## User Manual

Digital Wireless Systems

### ATW-DR3120

Dual Receiver

### ATW-DR3120DAN

Dual Receiver with Dante Output

### ATW-DT3101

Body-Pack Transmitter

### ATW-DT3102

Handheld Transmitter (without capsule)

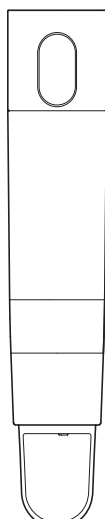
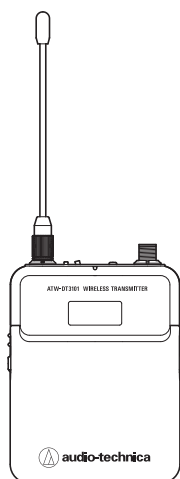
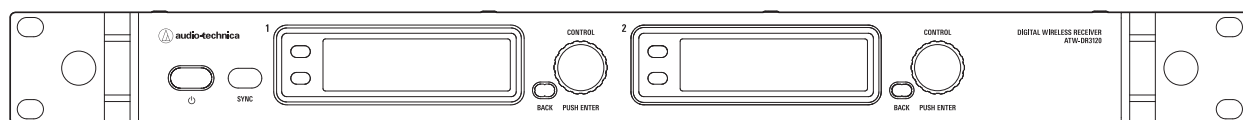

# Contents

<b>Introduction</b> .....	2	Setting the system-related functions.....	25
<b>Important information</b> .....	2	<b>How to attach the transmitter (ATW-DT3101)</b> .....	28
<b>Notes on use</b> .....	4	<b>Making connections (basic connections)</b> .....	28
<b>Maintenance</b> .....	4	<b>Making connections (cascade connections)</b> .....	29
<b>Part names and functions</b> .....	5	<b>Achieving stable reception</b> .....	30
ATW-DR3120/ATW-DR3120DAN .....	5	<b>Rack-mounting the receiver</b> .....	30
ATW-DT3101 .....	7	<b>Troubleshooting</b> .....	31
ATW-DT3102 .....	8	ATW-DR3120/ATW-DR3120DAN .....	31
<b>How to insert batteries</b> .....	9	ATW-DT3101/ATW-DT3102 .....	31
ATW-DT3101 .....	9	<b>Dimensions</b> .....	32
ATW-DT3102 .....	9	ATW-DR3120/ATW-DR3120DAN .....	32
<b>How to attach and remove the interchangeable microphone capsule (only for the ATW-DT3102)</b> .....	10	ATW-DT3101 .....	33
How to attach .....	10	ATW-DT3102 .....	33
How to remove .....	10	<b>Specifications</b> .....	34
<b>How to read the display</b> .....	11	Overall system specifications.....	34
ATW-DR3120/ATW-DR3120DAN .....	11	ATW-DR3120/ATW-DR3120DAN .....	34
ATW-DT3101/ATW-DT3102 .....	13	ATW-DT3101 .....	34
<b>How to operate</b> .....	14	ATW-DT3102 .....	35
Basic operation .....	14		
Using IR SYNC .....	14		
<b>Settings</b> .....	15		
ATW-DR3120/ATW-DR3120DAN .....	15		
ATW-DT3101/ATW-DT3102 .....	15		
<b>Setting the ATW-DR3120/ATW-DR3120DAN</b> .....	16		
List of setting items .....	16		
Setting the operating frequency .....	16		
Setting the channel name.....	16		
Setting the audio output.....	17		
Scanning for open channels .....	17		
Setting transmitters via IR SYNC.....	17		
Setting the security-related functions.....	18		
Setting the system-related functions.....	18		
Setting the network .....	21		
Setting the DANTE.....	22		
<b>Setting the ATW-DT3101/ATW-DT3102</b> .....	23		
List of setting items .....	23		
Setting the transmission frequency.....	23		
Setting the channel name.....	23		
Adjusting the microphone input gain .....	24		
Setting the connection of the input connector (only for the ATW-DT3101) ...	24		
Selecting the microphone input gain (only for the ATW-DT3101).....	24		
Setting the RF transmission output .....	24		
Setting the HPF (High-Pass Filter).....	24		
Setting the lock.....	24		
Setting the function for the function button.....	25		
Setting mute mode (only for the ATW-DT3101) .....	25		
Setting the security-related functions.....	25		

---

## Introduction

---

Thank you for purchasing this Audio-Technica product.

Before using the product, read through this user manual to ensure that you will use the product correctly. Please keep this manual for future reference.

The frequency band can be checked with the model number of the product. You can confirm the model number of your product with the rating label.

Due to federal, national, and other regulations, the device you are using may have a modified firmware version. Please check the version displayed on the device screen. Please make sure that you only use transmitters and receivers with each other that have the same firmware version installed, otherwise operation is not guaranteed.

Example: ATW-DR3120DE2

Band name

Band name	Operating frequencies
DE2	470.125 to 529.975 MHz
EE1	530.000 to 589.975 MHz
FF1	606.000 to 665.975 MHz

---

## Important information

---

### Warning:

- To prevent fire or shock hazard, do not expose this apparatus to rain or moisture.

### Caution:



- Do not expose this apparatus to drips or splashes.
- To avoid electric shock, do not open the cabinet.
- Refer servicing to qualified personnel only.
- Do not expose this apparatus to excessive heat such as that generated by sunshine, fire or other heat sources.
- Do not subject this apparatus to strong impact.
- This apparatus should be located close enough to the AC outlet so that you can easily grasp the power cord plug at any time.
- In case of emergency, disconnect the power cord plug of this apparatus quickly.
- Do not place any objects filled with liquids, such as vases, on this apparatus.
- To prevent fire, do not place any naked flame sources (such as lighted candles) on this apparatus.
- Do not install this apparatus in a confined space such as a bookcase or similar unit.
- Install this apparatus only in the places with good ventilation.
- To prevent fire, do not cover the ventilation of this apparatus with newspapers, tablecloths, curtains, etc.
- This apparatus with Class I construction shall be connected to the AC outlet with a protective grounding connection.
- This apparatus is not disconnected from the mains as long as it is connected to the AC outlet, even if the unit itself has been turned off.
- In order to maintain proper ventilation, do not place any objects around the rear of this apparatus.
- This apparatus should be placed at least 15 cm away from a rear wall. This apparatus should not be placed near to other electrical apparatuses. Keep the top and sides of this apparatus at least 10 mm away from any other surface if sitting on shelving, such as an audio apparatus rack. Failure to do so may cause this apparatus to overheat, which in turn may cause it or surrounding items to catch fire.

### Battery caution:

- Keep batteries out of the reach of children.
- Observe correct polarity as marked.
- Do not expose the battery to excessive heat such as sunshine, fire or the like.
- Always consider the environmental issues and follow local regulations when disposing of batteries.
- Remove depleted battery immediately.
- Danger of explosion if battery is incorrectly replaced. Replace only with the same or equivalent type.
- Use only disposable LR06(AA) alkaline or Ni-MH batteries.
- Do not use new and old batteries at the same time.
- Do not use different battery types or models.
- Do not use a leaking battery. If battery leakage occurs, avoid contact with skin. If contact occurs, immediately wash thoroughly with soap and water.
- If battery leakage comes into contact with your eyes, immediately flush with water and seek medical attention.

# Important information

## For customers in the USA/Canada

	<b>CAUTION</b> <b>RISK OF ELECTRIC SHOCK</b> <b>DO NOT OPEN</b>	
---	---	---

**Caution:** To prevent electric shock, do not remove the cover. There are no user-serviceable parts inside. Internal adjustments are for qualified professionals only. Refer all servicing to qualified service personnel.

	The lightning flash with arrowhead symbol, within an equilateral triangle, is intended to alert the user to the presence of uninsulated "dangerous voltage" within the product's enclosure that may be of sufficient magnitude to constitute a risk of shock to persons.
--	--

	The exclamation point symbol within an equilateral triangle is intended to alert the user to the presence of important operating and maintenance (servicing) instructions in the literature accompanying the product.
--	---

## Important Safety Instructions

1. Read these instructions.
2. Keep these instructions.
3. Heed all warnings.
4. Follow all instructions.
5. Do not use this apparatus near water.
6. Clean only with dry cloth.
7. Do not block any of the ventilation openings. Install in accordance with the manufacturer's instructions.
8. Do not install near any heat sources such as radiators, heat registers, stoves, or other apparatus (including amplifiers) that produce heat.
9. Do not defeat the safety purpose of the polarized or grounding plug. A polarized plug has two blades with one wider than the other. A grounding plug has two blades and a third grounding prong. The wide blade or the third prong is provided for your safety. If the provided plug does not fit into your outlet, consult an electrician for replacement of the obsolete outlet.
10. Protect the power cord from being walked on or pinched particularly at plugs, convenience receptacles, and the point where they exit from the apparatus.
11. Only use attachments/accessories specified by the manufacturer.
12. Use only with a cart, stand, tripod, bracket, or table specified by the manufacturer, or sold with the apparatus. When a cart is used, use caution when moving the cart/apparatus combination to avoid injury from tip-over.
13. Unplug this apparatus during lightning storms or when unused for long periods of time.
14. Refer all servicing to qualified service personnel. Servicing is required when the apparatus has been damaged in any way, such as power-supply cord or plug is damaged, liquid has been spilled or objects have fallen into the apparatus, the apparatus has been exposed to rain or moisture, does not operate normally, or has been dropped.



## FCC Notice

### Warning:

This device complies with Part 15 of the FCC Rules. Operation is subject to the following two conditions: (1) This device may not cause harmful interference, and (2) this device must accept any interference received, including interference that may cause undesired operation.

### Caution:

You are cautioned that any changes or modifications not expressly approved in this manual could void your authority to operate this equipment.

**Note:** This equipment has been tested and found to comply with the limits for a Class B digital device, pursuant to part 15 of the FCC Rules. These limits are designed to provide reasonable protection against harmful interference in a residential installation. This equipment generates, uses and can radiate radio frequency energy and, if not installed and used in accordance with the instructions, may cause harmful interference to radio communications. However, there is no guarantee that interference will not occur in a particular installation. If this equipment does cause harmful interference to radio or television reception, which can be determined by turning the equipment off and on, the user is encouraged to try to correct the interference by one or more of the following measures:

- Reorient or relocate the receiving antenna.
- Increase the separation between the equipment and receiver.
- Connect the equipment into an outlet on a circuit different from that to which the receiver is connected.
- Consult the dealer or an experienced radio/TV technician for help.

### Contact:

Responsible Company: Audio-Technica U.S., Inc.  
Address: 1221 Commerce Drive, Stow, Ohio 44224, USA  
Tel: 330-686-2600

## For customers in Canada

### IC statement

CAN RSS-Gen/CNR-Gen

---

## Notes on use

---

- Be sure to read the user manual for any device that you connect to the product.
- Disconnect the power cable from the outlet when this product is not in use.
- Turn off the power of this product before connecting or disconnecting cables.
- If you use the product near a TV or radio antenna, you may hear unwanted noise in the television or radio. If this occurs, move the product away from the device.
- Two waves of the same frequency can't be used simultaneously.
- Be careful of interference noise caused by the surrounding radio wave environment and use of multiple systems.
- Wireless systems may be affected by the spark noise of vehicles, the dimmers of lighting apparatus, computers, office automation devices, and electronic musical instruments. Place and use the product where it is less likely to be affected by the above items.
- Be sure to use this product in combination with devices specified by Audio-Technica.
- Be sure to use a general-purpose LAN cable (CAT5e or higher, a cable with shielding is recommended) that complies with the Ethernet standard.
- Disconnect the LAN cable when not using the network.
- Be sure the connected cable is plugged all the way into the product.
- When you connect the product to a mixer, turn off the phantom power supply.
- If you use the product close to an electronic or communications device (such as a mobile phone), the product may produce unwanted noise. If this occurs, move the product away from the device.
- When setting up the product, make sure there are no obstacles between the transmitter and the receiver that might block the signal.
- To prevent the batteries from wearing out, turn the transmitter off when not in use.
- Over time, discoloration may occur due to ultraviolet light (especially direct sunlight) and wear.
- Do not peel off the technical standards compliance certification sticker affixed to this product. Doing so will prevent you from using this product legally.
- It is legally prohibited to dismantle and modify this product. In addition, this product is so precisely manufactured that dismantling it could cause electric shock, failure, or fire. Never dismantle this product.

### Using multiple wireless systems

---

- If you use more than one device at the same time, use them in the same group.
- When using multiple units simultaneously, maintain 1 meter or more between transmitters and 3 meters or more between transmitters and receivers.
- When using multiple units, power on transmitters one by one, making sure there is no unwanted noise.
- When audio feedback (a beeping or squealing sound) occurs during use, turn down the output volume of the connected mixer/amplifier.

---

## Maintenance

---



- If the product becomes dirty or covered with dust, be sure to disconnect the power cable before wiping the product off with a dry and soft cloth.
- Do not use benzine, paint thinners, electrical contact cleaner, etc. They may deform or otherwise damage the product or cause operational failure.

## Part names and functions

### ATW-DR3120/ATW-DR3120DAN

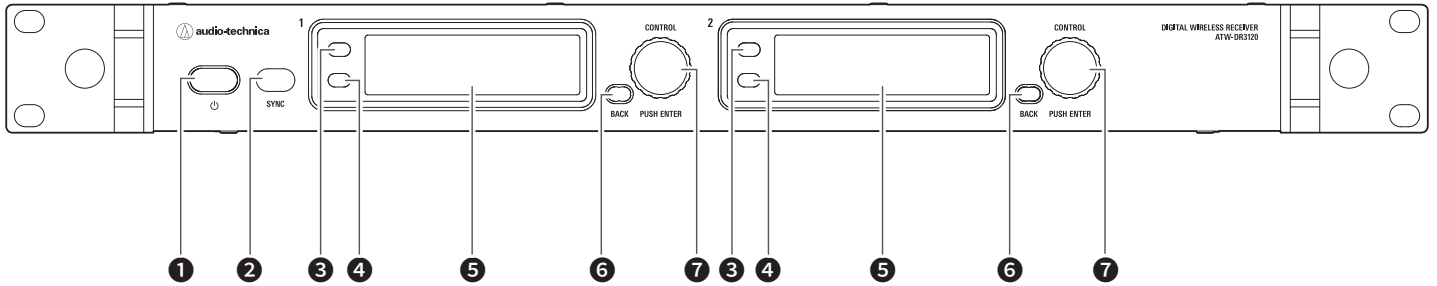
#### Front panel



- 1** Power button (  )  
Use to turn the receiver on or to place it in standby.  
(  : This symbol indicates standby.)
- 2** IR SYNC window  
Use to IR SYNC with the transmitter (ATW-DT3101, ATW-DT3102).
- 3** Function button 1  
Press to switch between the main screen and the level meter screen.
- 4** Function button 2  
Press to switch the display of the main screen.
- 5** Display  
Displays the receiver state and setting menus.
- 6** BACK button  
Press to take the display back one screen.  
Press and hold to return to the main screen.
- 7** Control dial  
When you press the dial, the setting menu is displayed. Turn the dial to select a setting and press the dial to confirm.  
When you press and hold the dial, QUICK SYNC starts.

# Part names and functions

## Rear panel

The figure below is of the ATW-DR3120.

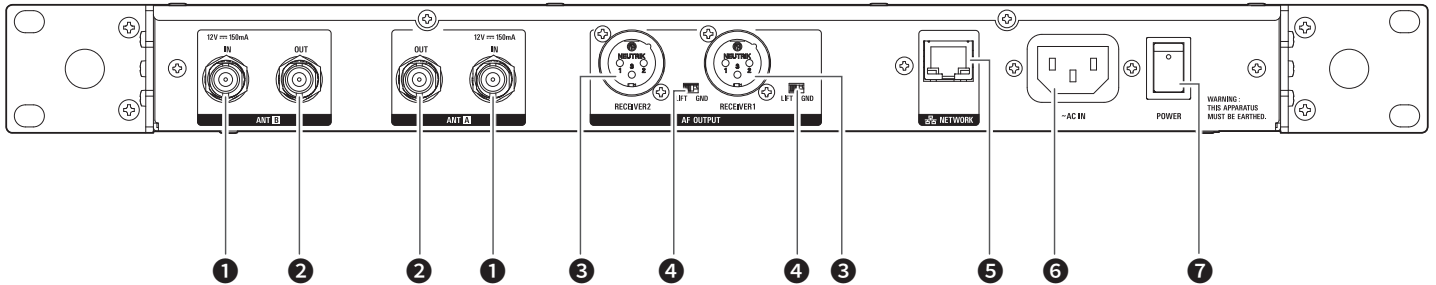

- 1** Antenna input jack  
 ( — — — : This symbol indicates direct current.)  
 Each jack supplies 12 VDC to a connected antenna.  
 Additionally, other compatible antenna accessories (sold separately) can be connected.
- 2** Antenna output jack  
 Distributes and outputs signals input to antennas A and B.  
 By using this jack, it is possible to connect up to four receivers (five total).
- 3** Balanced output jack (XLR 3-pin male)



- 4** Ground lift switch  
 This switch isolates the GND pin of the balanced/unbalanced output from the ground.  
 Normally this is kept in the GND position, but if a hum develops due to a ground loop, switch to the LIFT side.
- 5** Network interface  
 By connecting to a PC via Ethernet, you can use the PC for monitoring or control.  
 In the case of the ATW-DR3120DAN, this can also double as a DANTE output terminal.  
 LAN: 100Base-TX  
 DANTE: 1000Base-T
- 6** AC inlet  
 Connect the power cable.  
 ( ~ : This symbol indicates alternating current.)
- 7** Main power switch  
 Press to turn the power on/off.

# Part names and functions

## ATW-DT3101

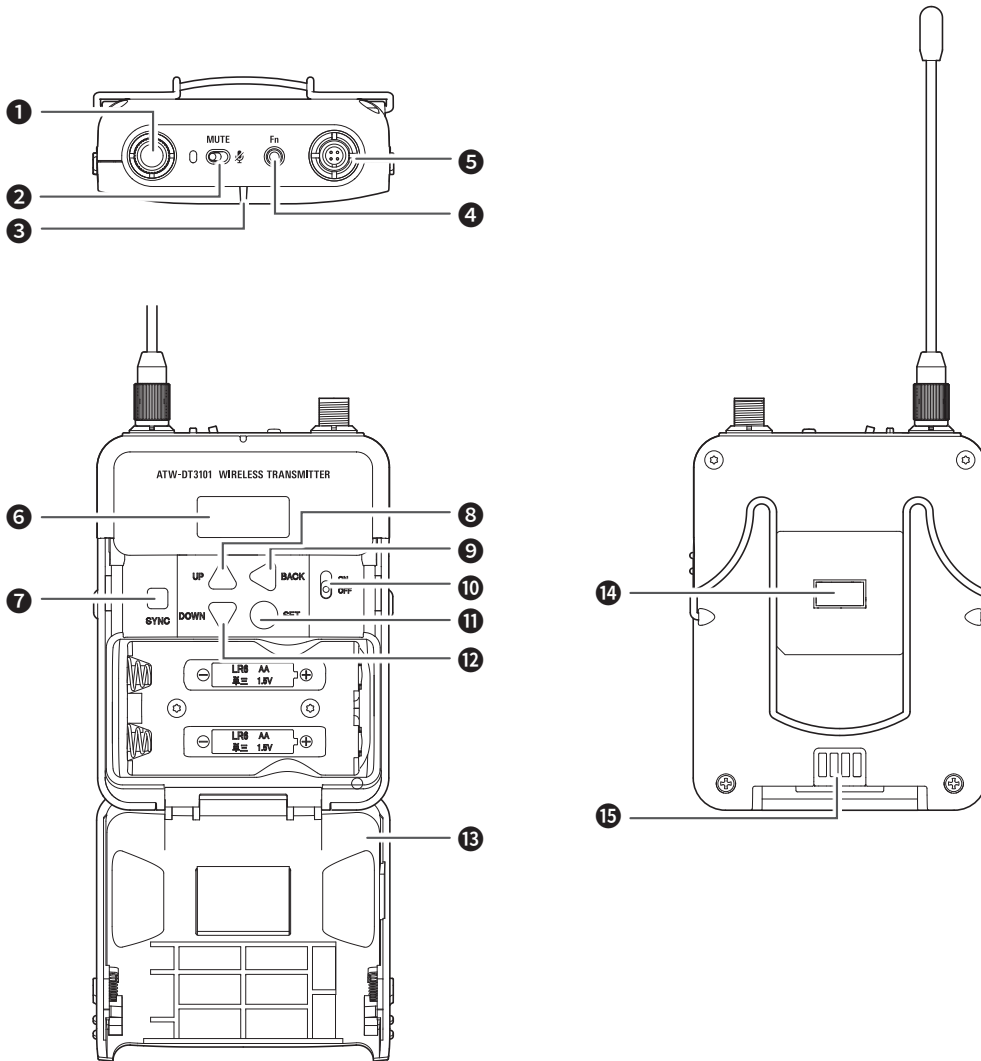

**1** Transmission antenna

**2** MUTE switch

Turns the mute function on/off.

**3** Indicator lamp

LED that shows the status of the transmitter.

When the power is turned on: Solid green

When the transmitter is muted: Solid red

**4** Function button

Press to turn the screen back on if it shuts off. Press and hold to perform the preselected function.

**5** Input connector

Connect a microphone, a headworn microphone, a guitar cable, etc.

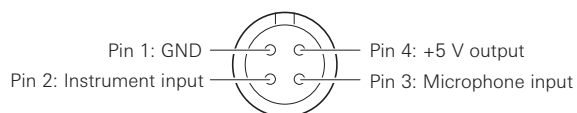

**6** Display

Shows the current status.

If no buttons are pressed for a period of 30 seconds, the display will turn off.

**7** SYNC button

Use to IR SYNC with the receiver (ATW-DR3120, ATW-DR3120DAN).

**8** UP button

Use to select various settings.

**9** BACK button

Press to take the display back one screen.

Press and hold to return to the main screen.

**10** Power switch

Use to turn the power on or off.

**11** SET button

Press to display the settings menu. Press the UP/DOWN button to select the setting item, and then press the SET button to confirm the selection.

**12** DOWN button

Use to select various settings.

**13** Battery cover

**14** IR SYNC window

Use to IR SYNC with the receiver.

**15** Charging terminal



## Part names and functions

### ATW-DT3102

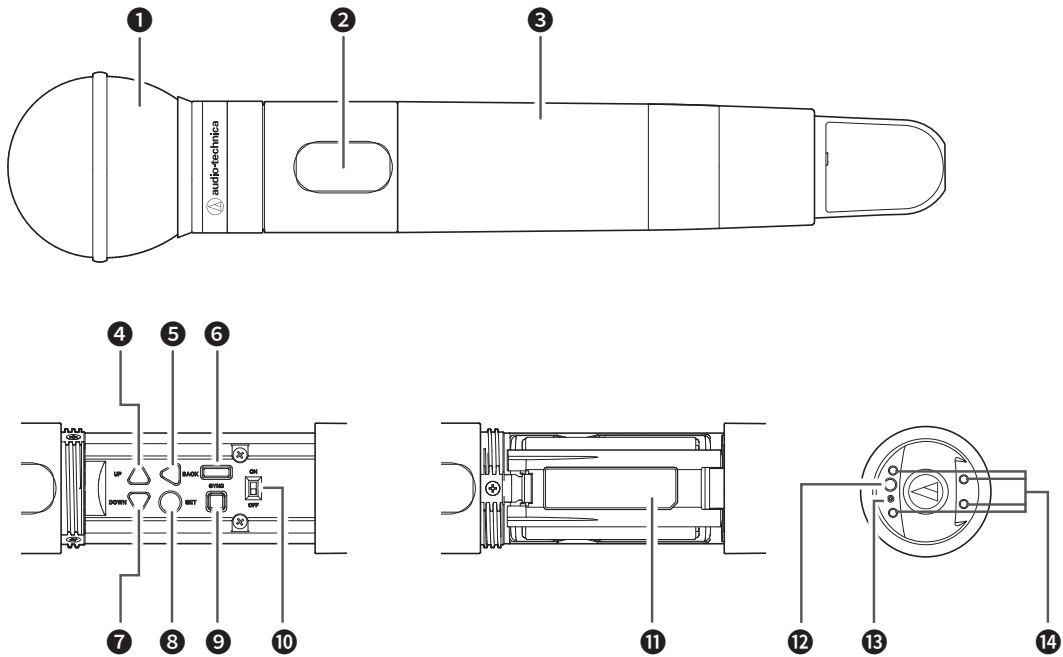

**1** Interchangeable microphone capsule (sold separately)

**2** Display

Shows the current status.

If no buttons are pressed for a period of 30 seconds, the display will turn off.

**3** Grip case

**4** UP button

Use to select various settings.

**5** BACK button

Press to take the display back one screen.

Press and hold to return to the main screen.

**6** IR SYNC window

Use to IR SYNC with the receiver.

**7** DOWN button

Use to select various settings.

**8** SET button

Press to display the settings menu. Press the UP/DOWN button to select the setting item, and then press the SET button to confirm the selection.

**9** SYNC button

Use to IR SYNC with the receiver (ATW-DR3120, ATW-DR3120DAN).

**10** Power switch

Use to turn the power on or off.

**11** Battery cover

**12** Function button

Press to turn the screen back on if it shuts off. Press and hold to perform the preselected function.

**13** Indicator lamp

LED that shows the status of the power supply/batteries.

When the power is turned on: Solid green

When the transmitter is muted: Solid red

**14** Charging terminal

# How to insert batteries

## ATW-DT3101

1. Slide the battery cover latches.

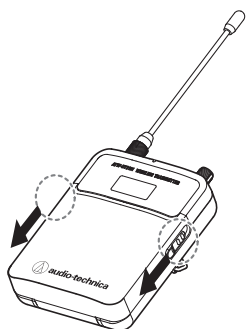

2. With the latches pressed in, open the battery cover.

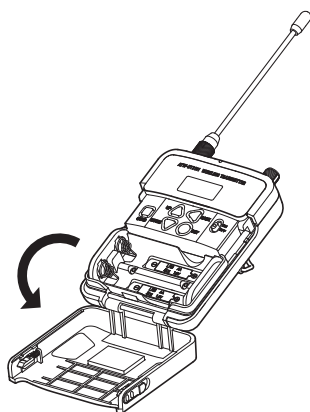

3. Insert the batteries according to the plus (+) and minus (-) marks found inside the battery compartment.

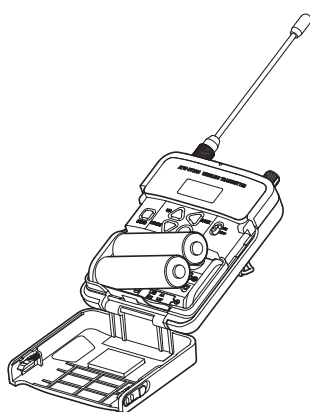

## ATW-DT3102

1. Rotate the grip case of the battery compartment.

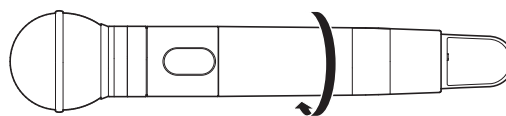

2. Open the battery cover.
  - Put your finger on the hook of the battery cover and pull it to open the battery cover.

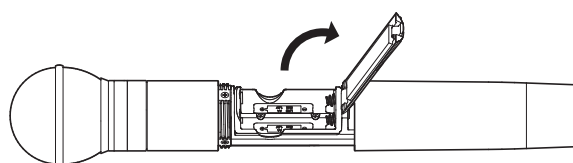

3. Insert the batteries according to the plus (+) and minus (-) marks found inside the battery compartment.

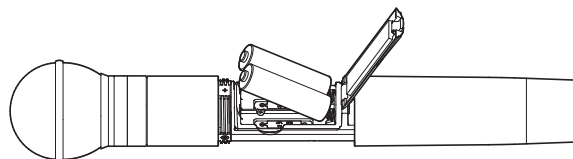

## How to attach and remove the interchangeable microphone capsule (only for the ATW-DT3102)

### How to attach

1. Attach the microphone capsule to the body of the transmitter.

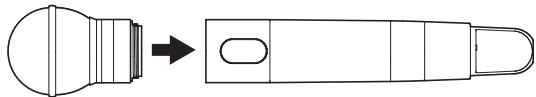

2. Rotate the microphone capsule clockwise to tighten it.

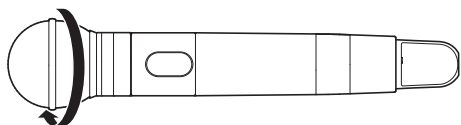

### How to remove

1. Rotate the microphone capsule counterclockwise to loosen it.

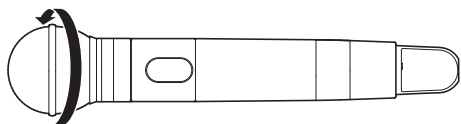

2. Remove the microphone capsule from the body of the transmitter.

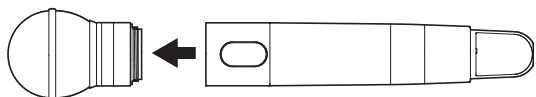

- Do not directly touch or scratch the connection surface.
- Be sure to turn off the power of the transmitter before attaching/removing the microphone capsule.
- Do not forcibly attach the microphone capsule. Doing so may damage the transmitter or microphone capsule.

# How to read the display

## ATW-DR3120/ATW-DR3120DAN

### Main screen

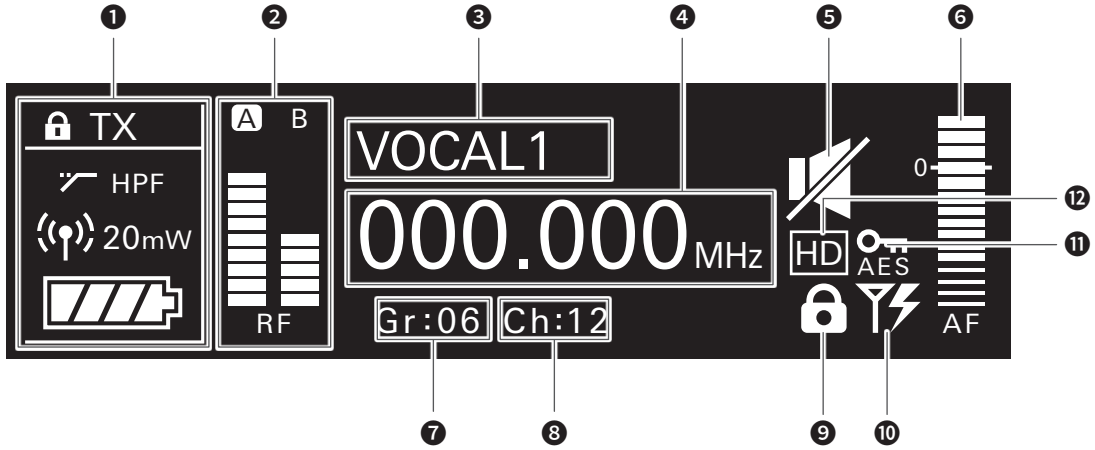

- 1** Transmitter information display area  
Information on the connected transmitter is displayed. Refer to "Transmitter information display area" (p. 11) for the screen display.
- 2** RF level indicator  
Displays the strength of RF reception for antennas A and B.
- 3** Name display  
Displays the specified name.
- 4** Frequency indicator  
Displays the set frequency.
- 5** Receiver mute indicator  
A speaker icon with a slash through it is displayed when the receiver is muted.
- 6** AF level indicator  
Displays the strength of the received audio signal.
- 7** Group indicator
- 8** Channel indicator
- 9** Lock status indicator
- 10** Antenna input power indicator  
An icon is displayed when the antenna input power supply is on.
- 11** AES-256 encryption mode indicator
- 12** HD mode indicator

### Transmitter information display area

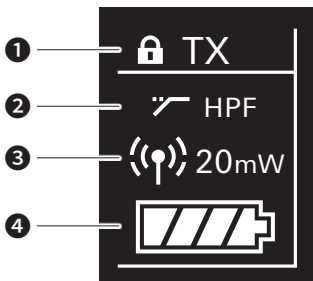

Normal

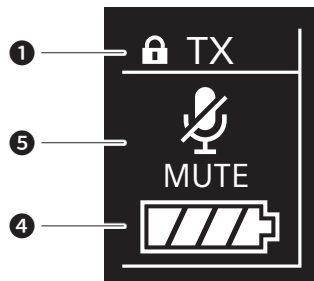

Muted

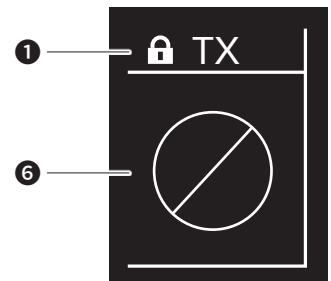

Non-communication

- 1** Lock status indicator
- 2** High-pass filter indicator
- 3** RF transmission output indicator
- 4** Battery level indicator
- 5** Transmitter mute indicator  
A microphone with a slash through it is displayed when the transmitter is muted.
- 6** Transmitter non-communication indicator

# How to read the display

## Level meter screen

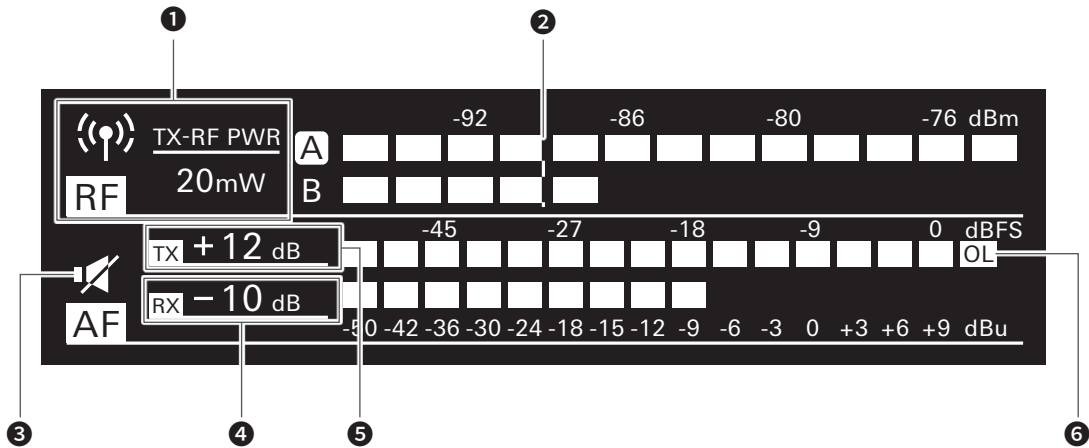

- 1** RF transmission output indicator (transmitter)
- 2** Marker (when the minimum hold function is on)  
Fixed to the minimum RF level.
- 3** Mute indicator  
A speaker icon with a slash through it is displayed when the receiver is muted.
- 4** Audio output indicator (receiver)
- 5** Gain indicator (transmitter)
- 6** Overload (excessive input) indicator

## Minimum hold function

If you press the BACK button on the level meter screen, the minimum hold function turns on and its marker is displayed.

- The marker indicates the lowest level of RF signal received from the transmitter.
- The marker does not move if the input RF level is higher than the marker position.
- If the RF level input is lower than the marker position, the marker moves in tandem with the RF level.
- To reset the marker position, press the BACK button again.

## Switching between screens

The screen is switched every time function button 1 is pressed.



Main screen

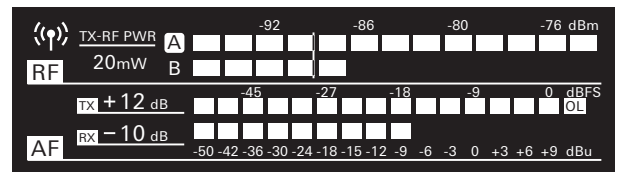

Level meter screen

The main screen is switched every time function button 2 is pressed.

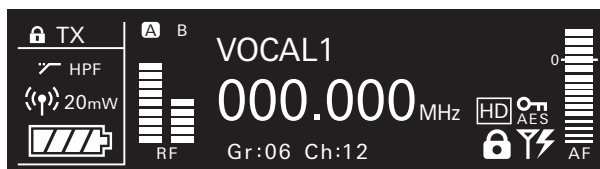

Main screen (frequency display)

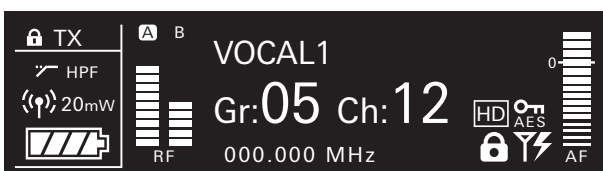

Main screen (group and channel display)



Main screen (channel name display)

# How to read the display

## ATW-DT3101/ATW-DT3102

The main screen is displayed when the power is switched on. If you press the UP/DOWN button on the main screen, the screen display is switched.

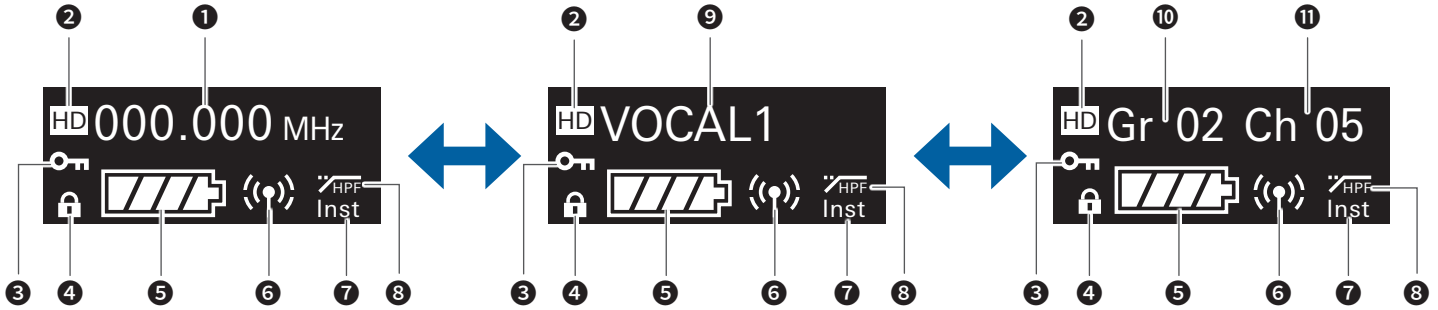

**1** Frequency indicator

Displays the set frequency.

**2** HD mode indicator

**3** AES-256 encryption mode indicator

**4** Lock status indicator

**5** Battery level indicator

- : 75% or more battery power remaining.
- : 50 to 75% battery power remaining.
- : 25 to 50% battery power remaining.
- : 25% or less battery power remaining.
- (Flicker): Replace the batteries.

**6** RF transmission output indicator

- : RF Power High (20 mW)
- : RF Power Mid (10 mW)
- : RF Power Low (2 mW)
- : RF Power Off

**7** Audio input indicator

- : When a guitar cable or something similar is connected
- : When a microphone is connected

**8** High-pass filter indicator

**9** Name display

Displays the specified name.

**10** Group indicator

**11** Channel indicator

# How to operate

## Basic operation

1. Turn on the main power switch of the receiver (ATW-DR3120/ATW-DR3120DAN).



2. Turn on the power button of the receiver (ATW-DR3120/ATW-DR3120DAN).

- The display lights and the main screen is displayed.

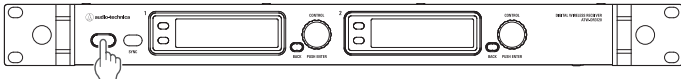

3. Set the operating frequency.

4. Turn on the power switch of the transmitter (ATW-DT3101/ATW-DT3102).

- The indicator lamp lights and the display shows the main screen.

ATW-DT3101

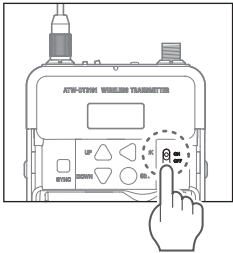

ATW-DT3102

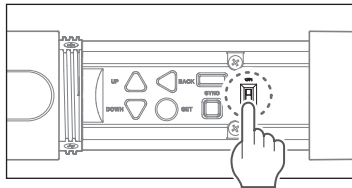

5. Set the transmission frequency.

6. Check the RF level indicator on the receiver.

- Check that antenna A or B lights up.

7. Speak into the microphone.

- Check that the AF level indicator lights up on the receiver.

- Turn on the power switch of the transmitter while holding down its DOWN button to start with the RF output in the off state (RF OFF mode).

## Using IR SYNC

This function allows you to set the transmitter with the details configured on the receiver.

1. When IR SYNC is started as part of setting the receiver, the "Communication in standby" screen is displayed.
2. Position the IR SYNC windows of the receiver and transmitter so they face each other.

ATW-DT3101

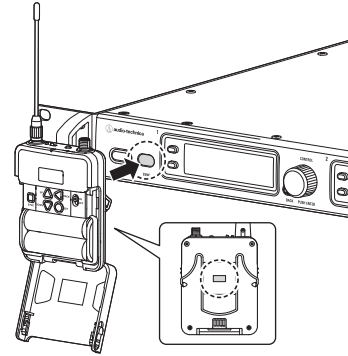

ATW-DT3102

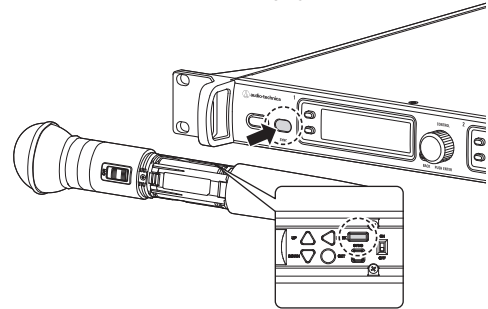

3. Press the SYNC button on the transmitter.

- Wait several seconds until communication is complete.

4. When the SYNC is complete, the "completed" screen is displayed.

- The transmitter is synced to the settings made on the receiver.
- If an error occurs in the SYNC process, an error screen opens, and then the display returns to the menu screen. Check the IR SYNC windows of the receiver and transmitter, and then SYNC again.
- To cancel the SYNC process, press the BACK button on the receiver. You will be returned to the previous screen.

## Using QUICK SYNC

QUICK SYNC allows you to easily send receiver settings to the transmitter.

1. Press and hold (for approximately 2 seconds) the control dial on the main screen.
2. Select [Sync], and then press the control dial.

# Settings

Various settings can be made from the menu screen shown on the display.

## ATW-DR3120/ATW-DR3120DAN

1. Press the control dial.
  - The menu screen appears.

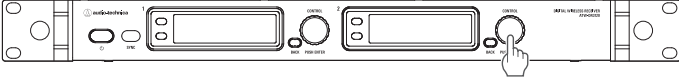

2. Turn the control dial to select the item you wish to set.



3. Press the control dial to open the settings screen of the selected item.
  - Press the BACK button to go back one screen.
  - To cancel partway through making a setting, press the BACK button.
  - While on the settings screen, the display will return to the main screen if approximately 60 seconds pass without a button or the control dial being used.

## ATW-DT3101/ATW-DT3102

1. Press the SET button.
  - The menu screen appears.

ATW-DT3101

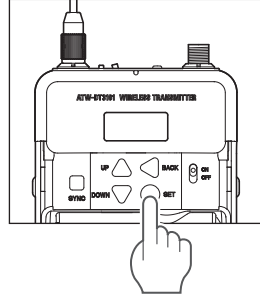

ATW-DT3102

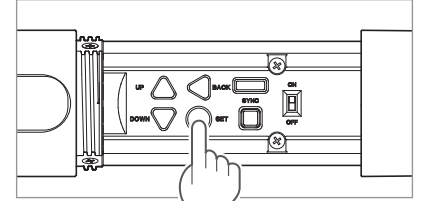

2. Press the UP/DOWN button to select the item you wish to set.

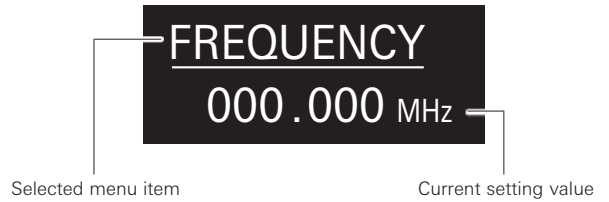

3. Press the SET button to display the settings screen for the selected item.
  - Press the BACK button to go back one screen.
  - To cancel partway through making a setting, press the BACK button.
  - While on the settings screen, the display will return to the main screen if approximately 30 seconds pass without a button being used.



# Setting the ATW-DR3120/ATW-DR3120DAN

## List of setting items

FREQUENCY	MANUAL	Set the operating frequency.
	Gr/Ch	
NAME		Set the channel name.
AUDIO	LINE/MIC	Set the line/microphone level.
	LEVEL	Set the audio output level.
	MIX OUTPUT	Set whether to mix and output the audio of the RECEIVER1 and RECEIVER2 receivers.
SCAN		Scan for open channels.
TX SYNC		Set transmitters via IR SYNC.
SECURITY	PIN	Set the PIN code for security.
	AES256	Set security with a higher level of confidentiality.
UTILITIES	RF MODE	Set the RF mode.
	LOCK	Set this function to prevent the receiver settings from being changed.
	ANT PWR	Set whether to turn power to the antenna input jacks on or off.
	Gr/Ch EDIT	The channels that compose the editable user groups (U1 and U2) can be edited.
	BACKUP FREQ	Set the backup frequency.
	AF METER	Switch the level meter on the main screen between receiver and transmitter.
	BRIGHTNESS	Set the display brightness.
	ACCESS	Set the user access level.
	RESET	This returns the receiver settings to their factory defaults.
	VERSION	This function displays product information such as the version of the receiver.
NETWORK	DEVICE ID	Set the receiver's ID number.
	IP SETTING	Set the IP.
	REMOTE CTRL	Set the remote control.
	SYSLOG	Set whether to send the log message to the Syslog server.
	DISCOVERY	Set automatic detection by the application.
	NTP	Set the NTP (Network Time Protocol).
	MAC ADDRESS	Display the MAC address.
DANTE*	INFO	Display the device name and channel label.
	IP SETTING	Set the DANTE's IP.
	MAC ADDRESS	Display the MAC address.
	VERSION	This function displays product information, such as the version of the DANTE.

\* ATW-DR3120DAN only

## Setting the operating frequency

### Setting manually

- From the menu screen, turn the control dial, select [FREQUENCY], and then press the control dial.
- Select [MANUAL] and press the control dial.
- Turn the control dial to set the first 3 digits. When finished setting them, press the control dial.
- Turn the control dial to set the last 3 digits. When finished setting them, press the control dial.
  - The setting is complete.

### Setting by group/channel

- From the menu screen, turn the control dial, select [FREQUENCY], and then press the control dial.
- Select [Gr/Ch] and press the control dial.
- Turn the control dial to set the group. When finished setting it, press the control dial.
- Turn the control dial to set the channel. When finished setting it, press the control dial.
  - The setting is complete.

## Setting the channel name

The characters that can be entered are shown below.

- The maximum number of characters that can be entered is 8.

Alphabetic (uppercase letters)	Numeric
Symbols (., +, -, #, &, period)	Space

- From the menu screen, turn the control dial, select [NAME], and then press the control dial.
- Turn the control dial, select the desired character, and then press the control dial.
  - The character is input and the cursor moves.
- Repeat the operation in Step 2 to enter all characters.
- Turn the control dial, select [End], and then press the control dial.
  - The setting is complete.

# Setting the ATW-DR3120/ATW-DR3120DAN

## Setting the audio output

### Setting the Line/Mic level

1. From the menu screen, turn the control dial, select [AUDIO], and then press the control dial.
2. Turn the control dial, select [LINE/MIC], and then press the control dial.
3. Turn the control dial, select [Line] or [Mic], and then press the control dial.
  - The setting is complete.

### Setting the audio output level

1. From the menu screen, turn the control dial, select [AUDIO], and then press the control dial.
2. Turn the control dial, select [LEVEL], and then press the control dial.
3. Turn the control dial to set the audio output level.
  - The level is adjusted by 1 dB each time you turn the control dial.
  - The level can be set to a value from -12 to 20 dB.
4. Press the control dial.
  - The setting is complete.

### Setting the audio output mixing

Set whether to mix and output the audio of the RECEIVER1 and RECEIVER2 receivers.

1. From the menu screen, turn the control dial, select [AUDIO], and then press the control dial.
2. Turn the control dial, select [MIX OUTPUT], and then press the control dial.
3. Turn the control dial, select [ON] or [OFF], and then press the control dial.
  - The setting is complete.

## Scanning for open channels

Scan for unused channels in the current environment for use.

1. From the menu screen, turn the control dial, select [SCAN], and then press the control dial.
2. Turn the control dial to select the group you want to scan. After selecting a group, press the control dial.

3. Turn the control dial to select the preferred threshold. After selecting the threshold, press the control dial.
  - You can select [Normal], [High], or [Low] sensitivity.

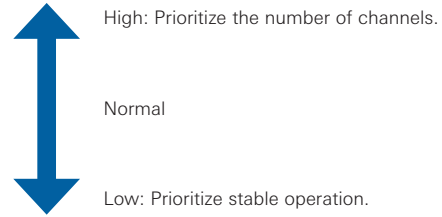

- The scan starts.

4. Confirm the scan result, turn the control dial, select [OK], and then press the control dial.
  - If you want to scan again, select [Retry].
5. The usable channels and frequencies are displayed in a list. Turn the control dial, select a usable channel, and then press the control dial.
  - The setting is complete.

## Setting transmitters via IR SYNC

This function allows you to set the transmitter with the details configured on the receiver. The following are the available settings and setting values:

Settings	Setting values
Freq	Current setting value, NoChange
Name	Current setting value, NoChange
Input	Mic, Inst, NoChange
Gain	-10 to +20 dB, NoChange
Sens.*	0, +10 dB, NoChange
RF Pwr	Low: 2 mW, Mid: 10 mW, High: 20 mW
HPF	OFF, 80 Hz, 120 Hz, 160 Hz, NoChange
Lock	Lock, Unlock, NoChange
Batt	Alkaline, Ni-MH, NoChange

\* ATW-DT3101 only

1. From the menu screen, turn the control dial, select [TX SYNC], and then press the control dial.
2. Turn the control dial to select a setting you would like to sync the transmitter to, and then press the control dial.
3. Turn the control dial to select the setting value, and then press the control dial.
4. Repeat Steps 2 and 3 for each setting you would like to sync the transmitter to.
5. Turn the control dial, select [SYNC START], and then press the control dial.
  - The communication function is in standby. Refer to "Using IR SYNC" (p. 14) for subsequent steps.

# Setting the ATW-DR3120/ATW-DR3120DAN

## Setting the security-related functions

### Setting the PIN code

Set the 4-digit code used when communicating with the transmitter. It is only possible to communicate between a receiver and transmitter on which the same PIN code has been set.

1. From the menu screen, turn the control dial, select [SECURITY], and then press the control dial.
2. Turn the control dial, select [PIN], and then press the control dial.
3. Turn the control dial, select the first number, and then press the control dial.
4. Repeat the operation in Step 3 to enter all the numbers.
5. After entering the fourth number, press the control dial.
6. Turn the control dial, select [Sync Now] or [Later], and then press the control dial.
  - If you select [Sync Now], the screen changes to the IR SYNC standby screen after the setting is complete. Refer to "Using IR SYNC" (p. 14) for subsequent steps.
  - If you select [Later], the setting will be completed, but you will have to perform IR SYNC separately or manually set the PIN code on the transmitter.

### Setting AES-256 encryption

Set security with a higher level of confidentiality.

1. From the menu screen, turn the control dial, select [SECURITY], and then press the control dial.
2. Turn the control dial, select [AES256], and then press the control dial.
3. Turn the control dial, select [ON] or [OFF], and then press the control dial.
  - If you select [Sync Now], the screen changes to the IR SYNC standby screen after the setting is complete. Refer to "Using IR SYNC" (p. 14) for subsequent steps.
  - If you select [Cancel], the setting is canceled.

## Setting the system-related functions

### Setting RF mode

- The default setting is [Normal].
1. From the menu screen, turn the control dial, select [UTILITIES], and then press the control dial.
  2. Turn the control dial, select [RF MODE], and then press the control dial.
  3. Turn the control dial, select [Normal] or [HD Mode], and then press the control dial.
    - By selecting [HD Mode] and lowering the transmission rate of the audio to narrow the occupied bandwidth of the radio wave, you can perform simultaneous operation with more channels than when [Normal] is selected.
    - If you select [Sync Now], the screen changes to the IR SYNC standby screen after the setting is complete. Refer to "Using IR SYNC" (p. 14) for subsequent steps.
    - If you select [Later], the setting will be completed, but you will have to perform IR SYNC separately or manually set the PIN code on the transmitter.

### Setting the lock

Set this function to prevent the receiver settings from being changed.

- The default setting is [Unlock].
1. From the menu screen, turn the control dial, select [UTILITIES], and then press the control dial.
  2. Turn the control dial, select [LOCK], and then press the control dial.
  3. Turn the control dial, select [Lock] or [Unlock], and then press the control dial.
    - The setting is complete.

### Setting the antenna power

Set whether to turn power to the antenna input jacks on or off.

- The default setting is [Off].
  - If set to [On], power is supplied to both antenna A and antenna B.
1. From the menu screen, turn the control dial, select [UTILITIES], and then press the control dial.
  2. Turn the control dial, select [ANT PWR], and then press the control dial.
  3. Turn the control dial, select [On] or [Off], and then press the control dial.
    - The setting is complete.

# Setting the ATW-DR3120/ATW-DR3120DAN

## Setting group/channel editing

### Editing the group/channel

The channels that compose the editable user groups (U1 and U2) can be edited.

- All channels are vacant in the initial state.
1. From the menu screen, turn the control dial, select [UTILITIES], and then press the control dial.
  2. Turn the control dial, select [Gr/Ch EDIT], and then press the control dial.
  3. Turn the control dial, select [EDIT], and then press the control dial.
  4. Turn the control dial, select a group, and then press the control dial.
  5. Turn the control dial, select a channel, and then press the control dial.
  6. Turn the control dial, select [SET] or [RESET], and then press the control dial.
    - By selecting [SET], you can set the frequency of the selected channel.
    - If you select [RESET], the frequency of the selected channel becomes blank.
  7. After setting all channels, turn the control dial, select [Sync] or [Save], and then press the control dial.
    - If you select [Save], the setting is completed.
    - If you select [Sync], the screen changes to the IR SYNC standby screen. Refer to "Using IR SYNC" (p. 14) for subsequent steps.

### Syncing the group/channel

The groups/channels that have been set with [EDIT] can be set on the transmitter in groups with IR SYNC.

1. From the menu screen, turn the control dial, select [UTILITIES], and then press the control dial.
2. Turn the control dial, select [Gr/Ch EDIT], and then press the control dial.
3. Turn the control dial, select [Gr/Ch SYNC], and then press the control dial.
4. Turn the control dial, select a group, and then press the control dial.
  - The screen changes to the IR SYNC standby screen. Refer to "Using IR SYNC" (p. 14) for subsequent steps.

## Setting the backup frequency mode

If you set the backup frequency in advance, you can switch the frequency of the transmitter and receiver with the transmitter. It is convenient to set this function when you want to switch the frequency easily.

- The default setting is [Off].
1. From the menu screen, turn the control dial, select [UTILITIES], and then press the control dial.
  2. Turn the control dial, select [BACKUP FREQ], and then press the control dial.
  3. Turn the control dial, select [On], and then press the control dial.
  4. Turn the control dial, select [Manual] or [Gr/Ch], and then press the control dial.
    - If you select [Manual], you can set the frequency.
    - If you select [Gr/Ch], you can set the group/channel.
  5. After setting each item, turn the control dial, select [Set] or [Sync], and then press the control dial.
    - If you select [Set], the setting will be completed, but you will have to perform IR SYNC separately or manually set the frequency backup mode on the transmitter.
    - If you select [Sync], the screen changes to the IR SYNC standby screen. Refer to "Using IR SYNC" (p. 14) for subsequent steps.

# Setting the ATW-DR3120/ATW-DR3120DAN

## Setting the AF level meter on the main screen

Switch the AF level meter on the main screen between [Receiver (Rx)] and [Transmitter (Tx)].

- The default setting is [Rx].
1. From the menu screen, turn the control dial, select [UTILITIES], and then press the control dial.
  2. Turn the control dial, select [AF METER], and then press the control dial.
  3. Turn the control dial, select [Rx] or [Tx], and then press the control dial.
    - The setting is complete.

## Setting the display brightness

- The default setting is [High].
1. From the menu screen, turn the control dial, select [UTILITIES], and then press the control dial.
  2. Turn the control dial, select [BRIGHTNESS], and then press the control dial.
  3. Turn the control dial, select [High] or [Low], and then press the control dial.
    - The setting is complete.

## Setting the user access level

Set the user access level.

- The default setting is [Free Tuning].
1. From the menu screen, turn the control dial, select [UTILITIES], and then press the control dial.
  2. Turn the control dial, select [ACCESS], and then press the control dial.
  3. Turn the control dial, select [Free Tuning] or [User Group Only], and then press the control dial.

Free Tuning	No limit.
User Group Only	The frequency can only be selected from a user group.

- The setting is complete.

## Resetting

This returns the receiver settings to their factory defaults.

1. From the menu screen, turn the control dial, select [UTILITIES], and then press the control dial.
2. Turn the control dial, select [RESET], and then press the control dial.
3. Turn the control dial, select [Yes], and then press the control dial.
4. After the confirmation screen is displayed, turn the control dial again to select [Yes], and then press the control dial.
  - The reset starts.

## Checking the version of the receiver

This function displays product information such as the version of the receiver.

1. From the menu screen, turn the control dial, select [UTILITIES], and then press the control dial.
2. Turn the control dial to select [VERSION].

# Setting the ATW-DR3120/ATW-DR3120DAN

## Setting the network

By connecting the receiver and PC, you can use the dedicated app for monitoring or controlling with the PC.

### Setting the receiver's ID number

1. From the menu screen, turn the control dial, select [NETWORK], and then press the control dial.
2. Turn the control dial, select [DEVICE ID], and then press the control dial.
3. Turn the control dial, select the device ID, and then press the control dial.
  - The setting is complete.

### Setting the IP

1. From the menu screen, turn the control dial, select [NETWORK], and then press the control dial.
2. Turn the control dial, select [IP SETTING], and then press the control dial.
3. Select an item you want to set and press the control dial.

IP Mode	Set how to obtain IP addresses. [Auto]: IP addresses are automatically assigned. [Static]: The specified static IP addresses are used.
IP Address*	Specify static IP addresses.
Subnet Mask*	Set the subnet mask.
Gateway*	Set the gateway.

\* This item can be set only when [IP Mode] is set to [Static].

4. Set each item.

### Setting the remote control

1. From the menu screen, turn the control dial, select [NETWORK], and then press the control dial.
2. Turn the control dial, select [REMOTE CTRL], and then press the control dial.
3. Select an item you want to set and press the control dial.

Port	Set the IP port number.
Notification	Receive notifications from the receiver during remote control.
LVL Notify*	Set whether to include the AF and RF level in the notification from the receiver during remote control.
Multicast Port*	Set the port number for multicast.
Multicast IP*	Set the address for multicast.

\* This item can be set only when [Notification] is set to [ON].

4. Set each item.

### Setting the log message

Set whether to send the log message to the Syslog server.

1. From the menu screen, turn the control dial, select [NETWORK], and then press the control dial.
2. Turn the control dial, select [SYSLOG], and then press the control dial.
3. Turn the control dial, select [On] or [Off], and then press the control dial.
  - The setting is complete.

• Syslog is a standard for transferring log messages across IP networks. It is used for administration of computer systems and security monitoring.

### Setting automatic detection by the application

1. From the menu screen, turn the control dial, select [NETWORK], and then press the control dial.
2. Turn the control dial, select [DISCOVERY], and then press the control dial.
3. Turn the control dial, select [On] or [Off], and then press the control dial.
  - The setting is complete.

### Setting NTP

Set the NTP (Network Time Protocol).

1. From the menu screen, turn the control dial, select [NETWORK], and then press the control dial.
2. Turn the control dial, select [NTP], and then press the control dial.
3. Select an item you want to set and press the control dial.

NTP	Set whether to enable or disable the NTP (Network Time Protocol).
Server Address* <sup>1</sup>	Set the NTP server address.
Port* <sup>1</sup>	Set the NTP port number.
Time zone* <sup>1</sup>	Set the time difference from the UTC (Coordinated Universal Time).
DST* <sup>1</sup>	Turn on/off daylight saving time.
Date* <sup>1,2</sup>	Set the starting and ending dates of daylight saving time.
Time* <sup>1,2</sup>	Set the starting and ending times of daylight saving time.

\*<sup>1</sup> This item can be set only when [NTP] is set to [ON].

\*<sup>2</sup> This item can be set only when [DST] is set to [ON].

4. Set each item.

# Setting the ATW-DR3120/ATW-DR3120DAN

## Setting the MAC address

1. From the menu screen, turn the control dial, select [NETWORK], and then press the control dial.
2. Turn the control dial to select [MAC ADDRESS].

## Setting the DANTE

This setting is used only for the ATW-DR3120DAN.

### Displaying the device name and channel label

1. From the menu screen, turn the control dial, select [DANTE], and then press the control dial.
2. Turn the control dial to select [INFO].

### Setting the DANTE's IP

1. From the menu screen, turn the control dial, select [DANTE], and then press the control dial.
2. Turn the control dial, select [IP SETTING], and then press the control dial.
3. Select an item you want to set and press the control dial.

IP Mode	Set how to obtain IP addresses. [Auto]: IP addresses are automatically assigned. [Static]: The specified static IP addresses are used.
IP Address*	Specify static IP addresses.
Subnet Mask*	Set the subnet mask.
Gateway*	Set the gateway.

\* This item can be set only when [IP Mode] is set to [Static].

4. Set each item.

## Setting the MAC address

1. From the menu screen, turn the control dial, select [DANTE], and then press the control dial.
2. Turn the control dial to select [MAC ADDRESS].

### Checking the version of the DANTE

This function displays product information, such as the version of the DANTE.

1. From the menu screen, turn the control dial, select [DANTE], and then press the control dial.
2. Turn the control dial to select [VERSION].

# Setting the ATW-DT3101/ATW-DT3102

## List of setting items

FREQUENCY	Manual	Set the transmission frequency.
	Gr/Ch	
NAME		Set the channel name.
GAIN		Adjust the microphone input gain.
INPUT*		Set the device connected to the input connector of the transmitter to [MIC] (microphone) or [INST] (guitar cable, etc.).
SENSITIVITY*		Select the microphone input gain from 0 dB and +10 dB.
RF POWER		Set the transmission output.
HPF		Set the HPF (High-Pass Filter).
LOCK		Set the button lock.
Fn BUTTON		Set the function allocation for the function button.
MUTE MODE*		Set mute mode.
SECURITY	PIN	Set the PIN code for security.
	AES256	Clear the AES-256 encryption when it has been set.
UTILITIES	RF MODE	Set the RF mode.
	TEST TONE	Output a test signal from the transmitter.
	BATTERY	Set the type of batteries used.
	LED	Set whether to keep the indicator lamp turned on at all times.
	ACCESS	Set the user access level.
	RESET	This returns the transmitter settings to their factory defaults.
	VERSION	This function displays the version of the transmitter.

\* ATW-DT3101 only

## Setting the transmission frequency

### Setting manually

- From the menu screen, press the UP/DOWN button to select [FREQUENCY], and then press the SET button.

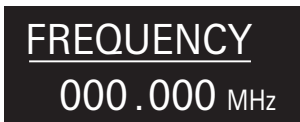

- After selecting [Manual], press the SET button.

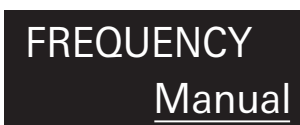

- Press the UP/DOWN button to set the first 3 digits. After completing the setting, press the SET button.
- Press the UP/DOWN button to set the last 3 digits. After completing the setting, press the SET button.
  - The setting is complete.

### Setting by group/channel

- From the menu screen, press the UP/DOWN button to select [FREQUENCY], and then press the SET button.

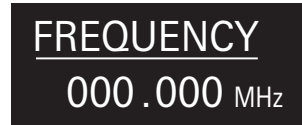

- After selecting [Gr/Ch], press the SET button.



- Press the UP/DOWN button to set the group. After completing the setting, press the SET button.
- Press the UP/DOWN button to set the channel. After completing the setting, press the SET button.
  - The setting is complete.

## Setting the channel name

The characters that can be entered are shown below.

- The maximum number of characters that can be entered is 8.

Alphabetic (uppercase letters)	Numeric
Symbols (., +, -, #, &, period)	Space

- From the menu screen, press the UP/DOWN button to select [NAME], and then press the SET button.



- Press the UP/DOWN button to select a desired character and press the SET button.
  - The character is input and the cursor moves.
- Repeat the operation in Step 2 to enter all characters.
  - If you don't enter 8 characters, press the UP/DOWN button to select [END], and then press the SET button.
- After entering the 8th character, press the SET button.
  - [END] is displayed.
- Press the SET button.
  - The setting is complete.



## Setting the ATW-DT3101/ATW-DT3102

### Adjusting the microphone input gain

1. From the menu screen, press the UP/DOWN button to select [GAIN], and then press the SET button.

GAIN  
0dB

2. Press the UP/DOWN button to select the gain you wish to set.
  - The level changes by 2 dB each time you press the UP/DOWN button.
  - It can be set to a value from -10 to +20 dB.
3. Press the SET button.
  - The setting is complete.

### Setting the connection of the input connector (only for the ATW-DT3101)

Set the device connected to the input connector of the transmitter to [MIC] (microphone) or [INST] (guitar cable, etc.).

1. From the menu screen, press the UP/DOWN button to select [INPUT], and then press the SET button.
2. Press the UP/DOWN button to select [Mic] or [Inst].
3. Press the SET button.
  - The setting is complete.

### Selecting the microphone input gain (only for the ATW-DT3101)

1. From the menu screen, press the UP/DOWN button to select [SENSITIVITY], and then press the SET button.

SENSITIVITY  
0dB

2. Press the UP/DOWN button and select [0dB] or [+10dB].
3. Press the SET button.
  - The setting is complete.

### Setting the RF transmission output

1. From the menu screen, press the UP/DOWN button to select [RF POWER], and then press the SET button.

RF POWER  
High:20mW

2. Press the UP/DOWN button to select the RF transmission output from [High:20mW], [Mid:10mW], and [Low:2mW].
3. Press the SET button.
  - The setting is complete.

### Setting the HPF (High-Pass Filter)

1. From the menu screen, press the UP/DOWN button to select [HPF], and then press the SET button.

HPF  
Off

2. Press the UP/DOWN button to select [Off], [80Hz], [120Hz], or [160Hz].
3. Press the SET button.
  - The setting is complete.

### Setting the lock

1. From the menu screen, press the UP/DOWN button to select [LOCK], and then press the SET button.

LOCK  
Unlock

2. Press the UP/DOWN button to select [Lock] or [Unlock].

Lock	Locks transmitter buttons
Unlock	Unlocks transmitter buttons

3. Press the SET button.
  - The setting is complete.

# Setting the ATW-DT3101/ATW-DT3102

## Setting the function for the function button

Select the function to be performed when the function button is pressed and held.

1. From the menu screen, press the UP/DOWN button to select [Fn BUTTON], and then press the SET button.

**Fn BUTTON**  
**Disable**

2. Press the UP/DOWN button to select the function that you want to set.

Disable	No function.
Mute* <sup>1</sup>	Mutes the transmitter.
MuteOnLock* <sup>1</sup>	Mutes the transmitter (even when transmitter buttons are locked).
Bkup Freq	Switches to the backup frequency mode. (When selected, set the frequency, group, and channel.)
RF Off* <sup>2</sup>	Turns off RF transmission output.

\*<sup>1</sup> ATW-DT3102 only

\*<sup>2</sup> This item cannot be selected when [MUTE MODE] is set to [RF Off].

3. Press the SET button.
  - The setting is complete.

## Setting mute mode (only for the ATW-DT3101)

Assign the function of the MUTE switch.

1. From the menu screen, press the UP/DOWN button to select [MUTE MODE], and then press the SET button.
2. Press the UP/DOWN button to select the function that you want to set.

Disable	No function.
Mute	Mutes the transmitter.
MuteOnLock	Mutes the transmitter (even when transmitter buttons are locked).
RF Off*	Turns off RF transmission output.

\* This item cannot be selected when [Fn Button] is set to [RF Off].

3. Press the SET button.
  - The setting is complete.

## Setting the security-related functions

### Setting the PIN code

Set the 4-digit code used when communicating with the receiver. It is only possible to communicate between a transmitter and receiver on which the same PIN code has been set.

- The default setting is [0000].
1. From the menu screen, press the UP/DOWN button to select [SECURITY], and then press the SET button.

2. Press the UP/DOWN button to select [PIN], and then press the SET button.
3. Press the UP/DOWN button to select the number you want to set, and then press the SET button.
  - The number is input and the cursor moves.
4. Repeat the operation in Step 3 to enter the remaining three numbers.
5. After entering the fourth number, press the SET button.
  - The setting is complete.

### Clearing the AES-256 encryption

Clear the AES-256 encryption when it has been set.

1. From the menu screen, press the UP/DOWN button to select [SECURITY], and then press the SET button.
2. Press the UP/DOWN button to select [AES256], and then press the SET button.
3. Press the UP/DOWN button to select [Off].
4. Press the SET button.
  - The setting is complete.

## Setting the system-related functions

### Setting RF mode

1. From the menu screen, press the UP/DOWN button to select [UTILITIES], and then press the SET button.
2. Press the UP/DOWN button to select [RF MODE], and then press the SET button.
3. Press the UP/DOWN button to select [Normal] or [HD Mode].
  - By selecting [HD Mode] and lowering the transmission rate of the audio to narrow the occupied bandwidth of the radio wave, you can perform simultaneous operation with more channels than when [Normal] is selected.
4. Press the SET button.
  - The setting is complete.

### Outputting a test signal from the transmitter

1. From the menu screen, press the UP/DOWN button to select [UTILITIES], and then press the SET button.
2. Press the UP/DOWN button to select [TEST TONE], and then press the SET button.
3. Press the UP/DOWN button to select [On], and then press the SET button.
  - A 1 kHz test signal is output as the audio signal in place of the microphone input.
  - While outputting a test signal, the microphone input will be muted.

# Setting the ATW-DT3101/ATW-DT3102

## Setting the battery type

Set the type of batteries used.

- The default setting is [Alkaline].
1. From the menu screen, press the UP/DOWN button to select [UTILITIES], and then press the SET button.



2. Press the UP/DOWN button to select [BATTERY] and press the SET button.

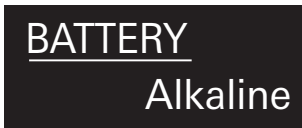

3. Press the UP/DOWN button to select the battery you wish to set.

Alkaline	Select when using alkaline batteries.
Ni-MH	Select when using nickel-metal hydride batteries.

4. Press the SET button.
  - The setting is complete.

• If the appropriate setting is not made for the batteries used, the battery power indicator will not display the correct information. Always set the type of battery according to the batteries used.

## Setting the indicator lamp

The indicator lamp can be turned [On] or [Off].

- The default setting is [On].
1. From the menu screen, press the UP/DOWN button to select [UTILITIES], and then press the SET button.



2. Press the UP/DOWN button to select [LED] and press the SET button.



3. Press the UP/DOWN button to select [On] or [Off].

4. Press the SET button.
  - The setting is complete.

## Setting the user access level

Set the user access level.

- The default setting is [Free].
1. From the menu screen, press the UP/DOWN button to select [UTILITIES], and then press the SET button.



2. Press the UP/DOWN button to select [ACCESS] and press the SET button.



3. Press the UP/DOWN button to select [Free] or [UserGroup].

Free	No limit.
UserGroup	The frequency can only be selected from a user group.

4. Press the SET button.
  - The setting is complete.

## Resetting

This returns the transmitter settings to their factory defaults.

1. From the menu screen, press the UP/DOWN button to select [UTILITIES], and then press the SET button.



2. Press the UP/DOWN button to select [RESET] and press the SET button.



3. Press the UP/DOWN button to select [Yes].

4. When the confirmation screen is shown, press the UP/DOWN button again to select [Yes].

5. Press the SET button.
  - The reset starts.

# Setting the ATW-DT3101/ATW-DT3102

---

## Checking the version of the transmitter

---

This function displays the version of the transmitter.

1. From the menu screen, press the UP/DOWN button to select [UTILITIES], and then press the SET button.



2. Press the UP/DOWN button to select [VERSION] and press the SET button.
  - The MPU and FPGA versions are displayed.

## How to attach the transmitter (ATW-DT3101)

The ATW-DT3101 is equipped with a clip that can be used to attach the transmitter to a belt, etc.

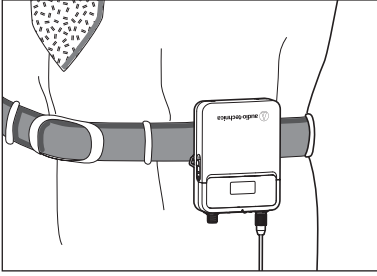

You can reverse the direction of the input connector by attaching the clip in the opposite direction.

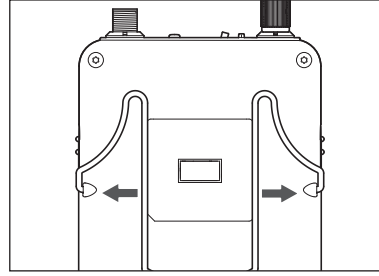

Pull both sides of the clip firmly to the outside to remove the clip from the transmitter.

## Making connections (basic connections)

This is an example of connections made when using one receiver.

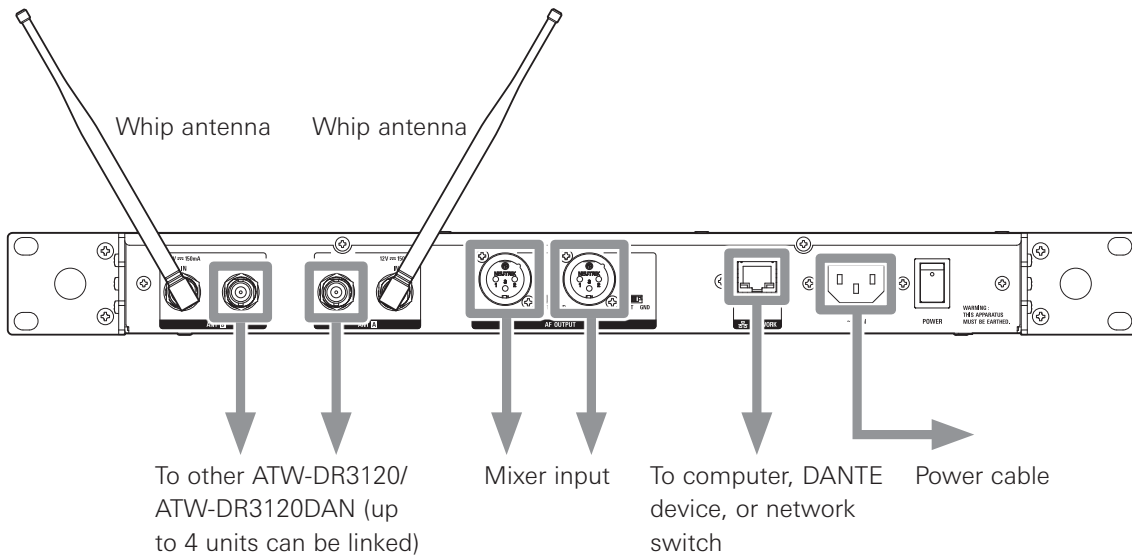

## Making connections (cascade connections)

Using the antenna output jack makes it possible to connect an additional 4 receivers (for a total of 5) in a cascade connection without using an antenna divider.

- When cascading receivers, connect either the included whip antennas or external antennas to the main receiver's antenna input jacks, and then cascade each receiver via BNC coaxial cables.

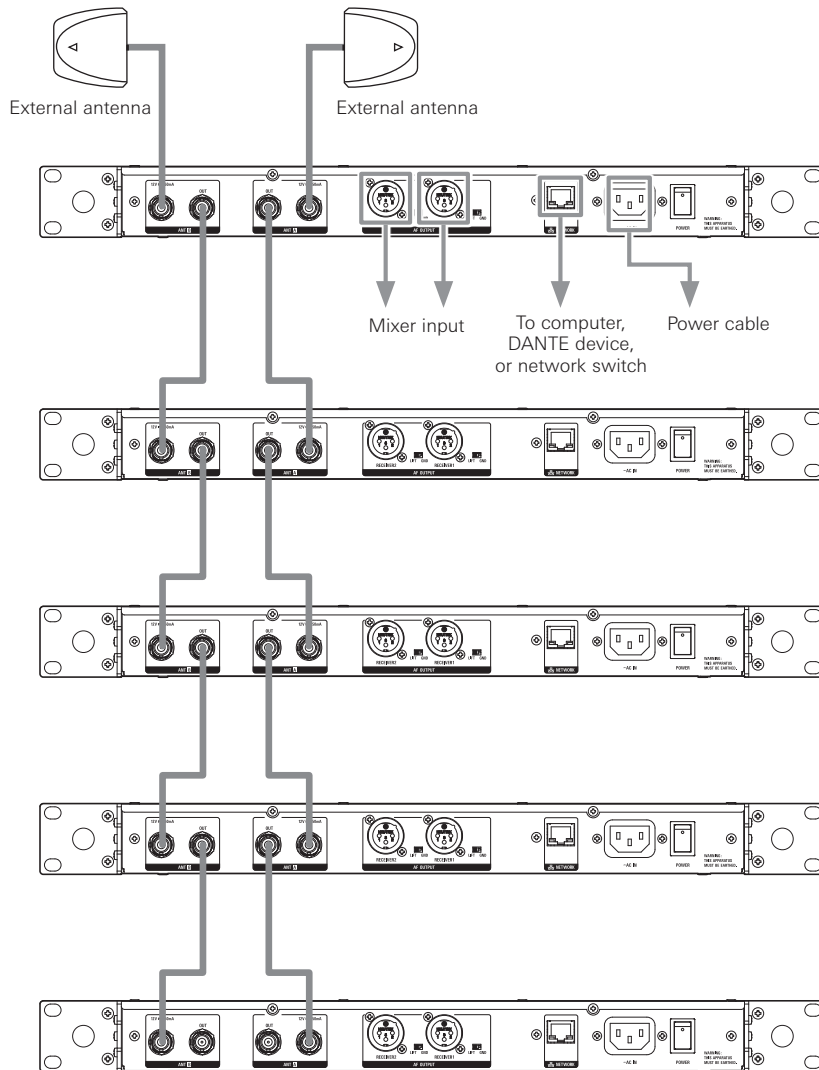

---

## Achieving stable reception

---

Low RF signal may result if there are obstructions between receiver antennas and transmitter(s). In such a case, reposition the antennas to get better reception. Use external antennas (sold separately) if the installation space is limited.

---

## Rack-mounting the receiver

---

- Screws for rack-mounting the receiver are not included.
- Consider ventilation when rack-mounting to avoid heat building up in the rack.
- When installing the product on a rack, make sure that the temperature inside the rack does not reach or exceed 45°C. Higher temperatures may negatively affect the internal parts of the product, causing the product to malfunction.
- Ensure there is at least a 10-millimeter space between the product and other devices or the top, bottom, and side faces of the rack.
- To ensure proper ventilation, do not place any objects around the rear of the product.
- The required rack specifications are as follows:
  - EIA-standard 19-inch rack
  - 1U-size attachable rack
  - Rack with a shelf on which the product is placed or a guide rail that supports the product
- You can ensure that the product is fixed in place in the rack more stably by using commercially available joint parts to mount the product on the rear guide rail with screws.

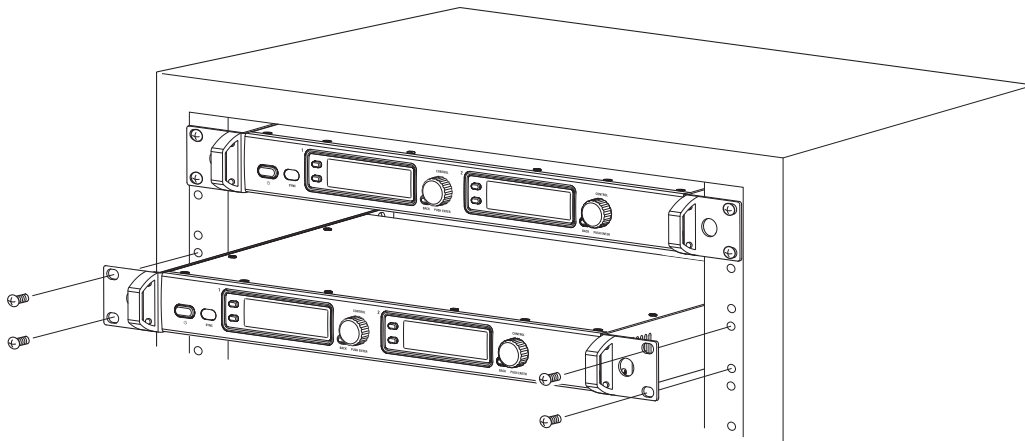

## Troubleshooting

### ATW-DR3120/ATW-DR3120DAN

Symptoms	Causes and countermeasures	Reference page
The power can't be turned on.	Confirm that the power cable is correctly connected.	-
There is no voice output. The voice output level is low.	Confirm that the transmitter/receiver channels are correct.	p. 16,p. 23
	Confirm that the power buttons of the transmitter/receiver are not turned off.	p. 14
	Confirm that the antennas are correctly connected.	-
	Confirm that all connected devices, such as a mixer, are correctly connected to the receiver.	-
	Confirm that the audio output isn't set to the minimum level.	p. 17
	Confirm that the audio output levels of devices (such as a mixer) connected to the receiver are not minimized.	-
	Check the PIN code, AES-256, and HD mode settings.	p. 18
Sound is distorted.	Confirm that the audio output level isn't too high.	p. 17
	Confirm that the volume of each connected device isn't too high.	-
There is unwanted noise. Sound drop-out occurs.	Confirm that there is no noise source, such as a fluorescent lamp or electric device, near the receiver.	-
	Confirm that multiple units are not being used simultaneously across different groups.	-
	Confirm that the output jack of the receiver is correctly connected.	p. 28
	Confirm that the receiver isn't taking power from an electrical outlet that is also being used by another noisy device.	-
	Confirm that other wireless systems nearby are not in use with the same frequency band.	-
	Check the PIN code, AES-256, and HD mode settings.	p. 18

### ATW-DT3101/ATW-DT3102

Symptoms	Causes and countermeasures	Reference page
The power can't be turned on.	Confirm that batteries are in place.	-
	Confirm that batteries are not depleted.	-
	Confirm that batteries are inserted in the right direction.	p. 9
There is no voice output. The voice output level is low.	Confirm that the transmitter/receiver channels are correct.	p. 16,p. 23
	Confirm that the power switch is not turned off.	p. 14
	Confirm that RF Power isn't off.	p. 24
	Confirm that the transmitter isn't in mute mode.	p. 25
	Confirm that the transmission output of the transmitter is not too low.	p. 24
	Confirm that the microphone or the guitar cable is not disconnected (only for the ATW-DT3101).	-
	Confirm that the output volume of the musical instrument, such as a guitar, isn't set to the minimum level.	-
	Confirm that the device connected to the input connector of the transmitter has been set correctly (only for the ATW-DT3101).	p. 24
	Confirm that the microphone capsule is connected properly (only for the ATW-DT3102).	p. 10
Sound is distorted.	Confirm that the gain setting of the transmitter is not too high.	p. 24
There is unwanted noise. Sound drop-out occurs.	Confirm that there is no noise source, such as a fluorescent lamp, LED lamp, or electric device, near the transmitter.	-
	Confirm that multiple units are not being used simultaneously across different groups.	-
	Confirm that the transmission output setting of the transmitter is not too high.	p. 24
	Check the PIN code, AES-256, and HD mode settings.	p. 25



# Dimensions

## ATW-DR3120/ATW-DR3120DAN

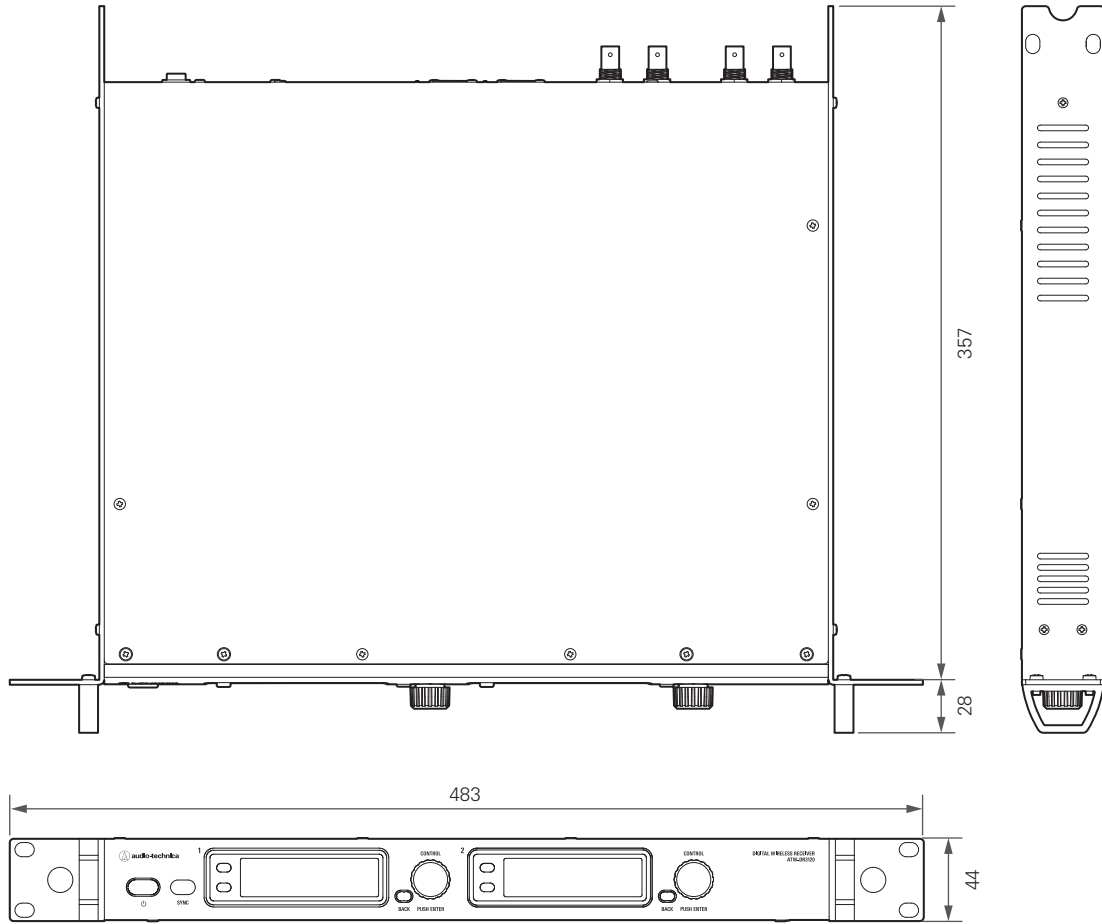

(Unit: mm)

## Dimensions

### ATW-DT3101

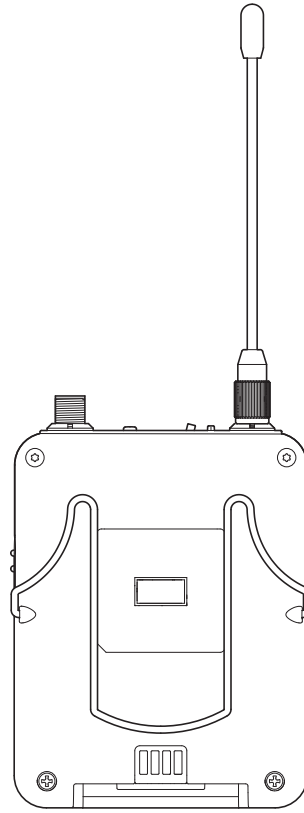
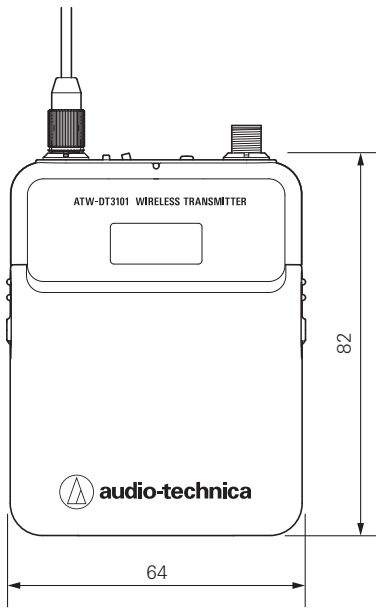
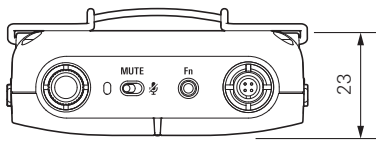

(Unit: mm)

### ATW-DT3102

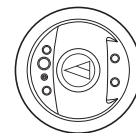
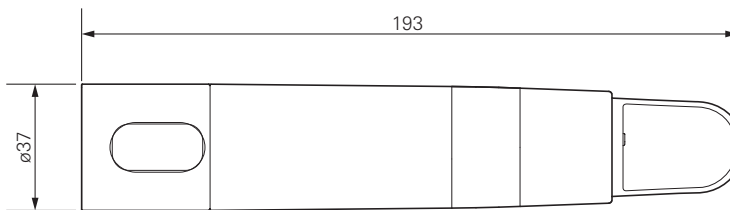

(Unit: mm)

# Specifications

## Overall system specifications

Operating frequencies	Band DE2: 470.125 to 529.975 MHz Band EE1: 530.000 to 589.975 MHz Band FF1: 606.000 to 665.975 MHz
Minimum frequency step	125 kHz
Modulation mode	$\pi/4$ -shift DQPSK
Occupied bandwidth	192 kHz or lower
Dynamic range	ATW-DT3101 (Mic input): 120 dB or higher, A-weighted, typical ATW-DT3101 (Inst input): 108 dB or higher, A-weighted, typical ATW-DT3102: 120 dB or higher, A-weighted, typical
Total harmonic distortion	0.1% or less (at 1 kHz, -20 dBFS)
Delay*1	2.5 ms or less
Operating range*2	120 m (394')
Frequency response*3	20 to 22,000 Hz
Number of channels that can be used simultaneously*4	Up to 17ch in one 6 MHz TV channel (22ch in one 8 MHz TV channel) with Normal mode UP to 24ch in one 6 MHz TV channel (32ch in one 8 MHz TV channel) with HD mode

\*1 During XLR output.

\*2 Open range environment with no interfering signals.

\*3 Depending on the attached microphone element.

\*4 Depending on the radio wave environment and the usage conditions.

## ATW-DR3120/ATW-DR3120DAN

Receiving system	True diversity
Image rejection	70 dB
RF sensitivity	-98 dBm ( $10^{-5}$ BER)
Maximum output level	18 dBV (Line), -12 dBV (Mic)
Antenna input	BNC-type, 50 ohms
Antenna power	12 VDC, 150 mA (combined)
Power supply	100 to 240 VAC (50/60 Hz)
Operating temperature range	-5°C to +40°C (23°F to 104°F)
Dimensions	483 mm (19.02") × 385 mm (15.16") × 44 mm (1.73") (W × D × H)
Weight	Approx. 4.1 kg (144.6 oz)
Included accessories	1/2 $\lambda$ whip antenna × 2, power cable, rubber leg × 4

## ATW-DT3101

RF output power	High: 20 mW, Mid: 10 mW, Low: 2 mW
-----------------	------------------------------------

Input connection

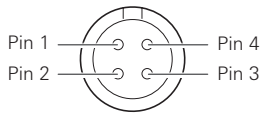

Four pin locking connector  
(Pin 1: GND, pin 2: INST INPUT, pin 3: MIC INPUT, pin 4: DC BIAS +5 V)

High-pass filter (low-freq. roll-off)	80 Hz, 120 Hz, 160 Hz, 12 dB/octave
Power supply	Two alkaline or nickel-metal hydride 1.5 V AA batteries
Operating temperature range	-5°C to +40°C (23°F to 104°F)
Battery life	When using nickel-metal hydride 1.5 V AA batteries: Approx. 7 hours (1900 mAh; High), approx. 9 hours (2500 mAh; High) When using alkaline 1.5 V AA batteries: Approx. 6 hours (High)
Dimensions	64 mm (2.52") × 23 mm (0.91") × 82 mm (3.23") (W × D × H)
Weight (without batteries)	Approx. 105 g (3.7 oz)
Included accessories	Pouch

## Specifications

### ATW-DT3102

RF output power	High: 20 mW, Mid: 10 mW, Low: 2 mW
High-pass filter (low-freq. roll-off)	80 Hz, 120 Hz, 160 Hz, 12 dB/octave
Power supply	Two alkaline or nickel-metal hydride 1.5 V AA batteries
Operating temperature range	-5°C to +40°C (23°F to 104°F)
Battery life	When using nickel-metal hydride 1.5 V AA batteries: Approx. 7 hours (1900 mAh; High), approx. 9 hours (2500 mAh; High) When using alkaline 1.5 V AA batteries: Approx. 6 hours (High)
Dimensions	193 mm (7.60") × 37 mm (1.46") (without microphone capsule)
Weight (without batteries)	Approx. 205 g (7.23 oz)
Included accessories	Pouch, AT8456a Quiet-Flex™ microphone stand clamp

For product improvement, the product is subject to modification without notice.

**Audio-Technica Corporation**

2-46-1 Nishi-naruse, Machida, Tokyo 194-8666, Japan

[www.audio-technica.com](http://www.audio-technica.com)

©2020 Audio-Technica Corporation

Global Support Contact: [www.at-globalsupport.com](http://www.at-globalsupport.com)

232417010-02-01 Ver. 1 2020.08.15